

**GERMAN STYLE PROFILE CROSS REFERENCE**

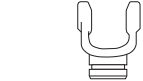

\*Inner Hole Star Shape

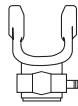
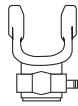
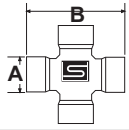

TYPE	UNIVERSAL JOINT	QUICK RELEASE YOKE (1 3/8"-6)	QUICK RELEASE YOKE (1 3/8"-21)	PROFILE TUBE YOKES	PROFILE TUBE	COLOR CODE	ROLL PIN
10	S.02444 A = 22mm B = 55mm	S.06008	S.06009	S.06000 23.5mm	S.04703.5 00a 23.5mm	White	S.01207 8 x 50mm
				S.06001 30mm	S.04705.5 0a 30mm	Red Oxide	
11	S.02445 A = 27mm B = 70mm	S.06018	S.06019	S.06010 34.5mm	S.04190.5 0v 34.5mm	Orange	S.01235 10 x 65mm
				S.06011 41mm	S.04192.5 1 41mm	Green	
12	S.02446 A = 34mm B = 90mm	S.06028	S.06029	S.06020 39.5mm	S.04193.5 1b 39.5mm	Black	S.01238 10 x 90mm
				S.06021 48mm	S.04194.5 2a 48mm	Red	
12	S.02446 A = 34mm B = 90mm	S.06028	S.06029	S.06022* 51mm	S.04820.5* S4 51mm		S.01238 10 x 90mm
				S.06023* 61mm	S.04821.5* S5 61mm		
20	S.02447 A = 24mm B = 61mm	S.06038	S.06039	S.06030 34.5mm	S.04190.5 0v 34.5mm	Orange	S.01235 10 x 65mm
				S.06031 41mm	S.04192.5 1 41mm	Green	
20	S.02447 A = 24mm B = 61mm	S.06038	S.06039	S.06032 23.5mm	S.04703.5 00a 23.5mm	White	S.01228 8 x 55mm
				S.06033 30mm	S.04705.5 0a 30mm	Red Oxide	
21	S.02448 A = 27mm B = 74.5mm	S.06048	S.06049	S.06040 34.5mm	S.04190.5 0v 34.5mm	Orange	S.01235 10 x 65mm
				S.06041 41mm	S.04192.5 1 41mm	Green	
21	S.02448 A = 27mm B = 74.5mm	S.06048	S.06049	S.06043 39.5mm	S.04193.5 1b 39.5mm	Black	S.01237 10 x 80mm
				S.06042 48mm	S.04194.5 2a 48mm	Red	
22	S.02449 A = 30mm B = 92mm	S.06058	S.06059	S.06050 39.5mm	S.04193.5 1b 39.5mm	Black	S.01237 10 x 80mm
				S.06051 48mm	S.04194.5 2a 48mm	Red	
22	S.02449 A = 30mm B = 92mm	S.06058	S.06059	S.06052* 51mm	S.04820.5* S4 51mm		S.01237 10 x 80mm
				S.06053* 61mm	S.04821.5* S5 61mm		
24	S.02496 A = 35mm B = 106.5mm	S.06068	S.06069	S.06060* 51mm	S.04820.5* S4 51mm		S.01172 1/2" x 3 1/2"
			S.14431 (1 3/4 -20)	S.06061* 61mm	S.04821.5* S5 61mm		
35	S.06450 A = 32mm B = 76mm	S.06078	S.06079	S.06072 39.5mm	S.04193.5 1b 39.5mm	Black	S.01237 10 x 80mm
				S.06073 48mm	S.04194.5 2a 48mm	Red	
35	S.06450 A = 32mm B = 76mm	S.06078	S.06079	S.06074* 51mm	S.04820.5* S4 51mm		S.01237 10 x 80mm
				S.06075* 61mm	S.04821.5* S5 61mm		
36	S.06451 A = 36mm B = 89mm	S.06088	S.06089	S.06082 39.5mm	S.04193.5 1b 39.5mm	Black	S.01238 10 x 90mm
				S.06083 48mm	S.04194.5 2a 48mm	Red	
36	S.06451 A = 36mm B = 89mm	S.06088	S.06089	S.06084* 51mm	S.04820.5* S4 51mm		S.01238 10 x 90mm
				S.06085* 61mm	S.04821.5* S5 61mm		

**ITALIAN STYLE PROFILE CROSS REFERENCE**

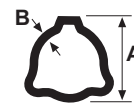
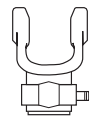
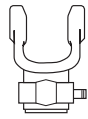
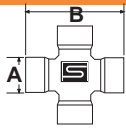

TYPE	UNIVERSAL JOINT	QUICK RELEASE YOKE (1 3/8" - 6)	QUICK RELEASE YOKE (1 3/8" - 21)	PROFILE TUBE YOKES	PROFILE TUBE	COLOR CODE	ROLL PIN
1	S.02498 A = 22mm B = 54mm	S.06008	S.06009	S.06070 A=26mm B=3.5mm	S.04811.5 A=26mm B=3.5mm	White	S.01207 8 x 50mm
				S.06071 A=33mm B=2.6mm	S.04810.5 A=33mm B=2.6mm	Red Oxide	
2	S.02447 A = 24mm B = 61mm	S.06038	S.06039	S.06080 A=29mm B=3.5mm	S.04813.5 A=29mm B=3.5mm	Black	S.01228 8 x 55mm
				S.06081 A=36mm B=3.4mm	S.04812.5 A=36mm B=3.4mm	Red	
3	S.02445 A = 27mm B = 70mm	S.06018	S.06019	S.06090 A=36mm B=3.4mm	S.04812.5 A=36mm B=3.4mm	Red	S.01230 8 x 70mm
				S.06091 A=43mm B=3.0mm	S.04814.5 A=43mm B=3.0mm	Pink	
4	S.02448 A = 27mm B = 74.5mm	S.06048	S.06049	S.06100 A=36mm B=4.5mm	S.04815.5 A=36mm B=4.5mm	Lt Blue	S.01230 8 x 70mm
				S.06101 A=43mm B=3.0mm	S.04814.5 A=43mm B=3.0mm	Pink	
5	S.02497 A = 30mm B = 80mm	S.06118	S.06119	S.06110 A=45mm B=4.0mm	S.04816.5 A=45mm B=4.0mm	Orange	S.01236 10 x 70mm
				S.06111 A=52mm B=3.0mm	S.04839.5 A=52mm B=3.0mm	Khaki	
6	S.02449 A = 30mm B = 92mm	S.06058	S.06059	S.06120 A=45mm B=4.0mm	S.04816.5 A=45mm B=4.0mm	Orange	S.01237 10 x 80mm
			S.14430 1 3/4 x 20	S.06121 A=54mm B=4.0mm	S.04817.5 A=54mm B=4.0mm	Yellow	
7 (Old Style)	S.02458 A = 30mm B = 106.5mm	S.06138	S.06139	S.06130 A=45mm B=5.5mm	S.04818.5 A=45mm B=5.5mm	Purple	S.01237 10 x 80mm
				S.06131 A=54mm B=4.0mm	S.04817.5 A=54mm B=4.0mm	Yellow	
7 (New Style)	S.02499 A = 35mm B = 94mm	S.06098	S.06099	S.06016 A=45mm B=5.5mm	S.04818.5 A=45mm B=5.5mm	Purple	S.01237 10 x 80mm
				S.06017 A=54mm B=4.0mm	S.04817.5 A=54mm B=4.0mm	Yellow	
8 (Old Style)	S.02496 A = 35mm B = 106.5mm	S.06068	S.06069	S.06140 A=45mm B=5.5mm	S.04818.5 A=45mm B=5.5mm	Purple	S.01237 10 x 80mm
				S.06141 A=54mm B=4.0mm	S.04817.5 A=54mm B=4.0mm	Yellow	
8 (New Style)	S.02496 A = 35mm B = 106.5mm	S.06068	S.06069	S.07549 A=54mm B=4.0mm	S.04817.5 A=54mm B=4.0mm	Yellow	S.11482 12 x 90mm
				S.07549 A=63mm B=4.0mm	S.07547.5 A=63mm B=4.0mm	Green	

**Universal Joint**

**10**  
2100 TYPE

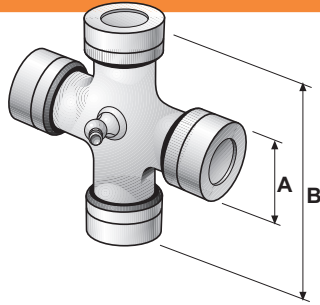

**S.02444**  
10.01.00

A = 22mm 7/8"  
B = 54.8mm 2 5/32"

**Power-Torque Limit**

RPM	540 	1000 
h.p.	12	19

Values relate to continuous load, 5° working angle, 1000 hrs life.

**NOTE:** P.T.O. tubing is sold in 5 foot lengths. If a longer length is required order the same number without the (.5) and a 10 ft length will be shipped. **NOTE:** Truck shipments only.

**Q. R. Yokes**

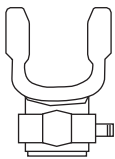

**S.06008**  
10.10.00

**S.06009**  
10.50.00

**S.06004**  
10.11.00

**Interfering Clamp Bolt Yokes**

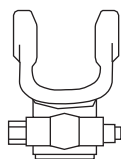

**S.07501**  
10.10.06

**S.07511**  
10.10.15

**Profile Tube Yokes**

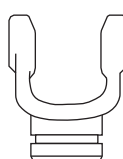

**S.06000**  
10.48.00

**S.06001**  
10.49.00

**Profile Tubes**  
(see note above)

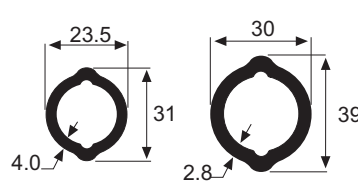

**S.04703.5**  
Ooa

**S.04705.5**  
Oa



**S.01207**  
8 x 50mm

**Slip Clutches Torque Limiter**

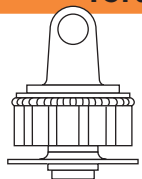

**K31 300NM S.06006**  
2660 in/lb (1 row)

**K32 600NM S.06007**  
5320 in/lb (2 row)

**Shear Bolt Limiter**

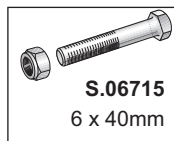
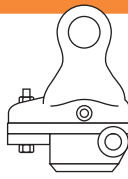

**S.06715**  
6 x 40mm

**S.06155**  
630NM  
5580 in lb

**Free Wheel Overrunning Clutch**

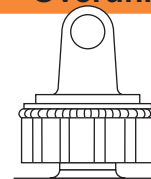

**S.06005**  
F3

**Keyway Yokes**

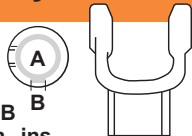

A		B		
mm	ins	mm	ins	
20	-	6	-	<b>S.06540</b>
25	-	8	-	<b>S.06541</b>
30	-	8	-	<b>S.06542</b>
35	-	10	-	<b>S.06503</b>
-	1"	-	1/4"	<b>S.06192</b>
-	1 1/8"	-	1/4"	<b>S.06193</b>
-	1 1/4"	-	1/4"	<b>S.06194</b>

**Pinhole Yokes**

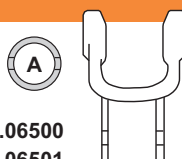

A		
mm	ins	
20	-	<b>S.06500</b>
25	-	<b>S.06501</b>
30	-	<b>S.06502</b>
-	1"	<b>S.06122</b>
-	1 1/8"	<b>S.06123</b>
-	1 1/4"	<b>S.06124</b>
-	1 3/8"	<b>S.06015</b>

**Clamp Yokes**

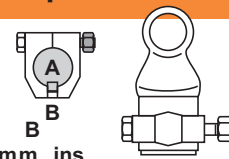

A		B		
mm	ins	mm	ins	
25	-	8	-	<b>S.06093</b>
30	-	8	-	<b>S.06094</b>
-	1"	-	1/4"	<b>S.06259</b>
-	1 1/8"	-	1/4"	<b>S.06065</b>
-	1 1/4"	-	1/4"	<b>S.06066</b>

**Complete Shafts & Guards**

**Complete Shafts  
with 'Easy-Lock' Guards  
conforming to CEN 1152**

**10**  
2100 TYPE

Min		A		Max		Shafts
mm	ins	mm	ins	mm	ins	Ooa/Oa
1000	39"	1800	71"			S.06602
1500	59"	2800	110"			S.06603

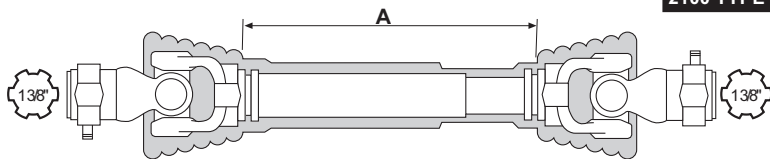

**'Easy-Lock' Guards - 250**

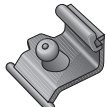
Ring Kit* S.56500 41mmØ x2	A		Guard	Nipple Lock S.56509
	mm	ins		
	750	29 1/2"	S.59605	
	1000	39 1/2"	S.59606	
	1300	51 1/2"	S.59607	

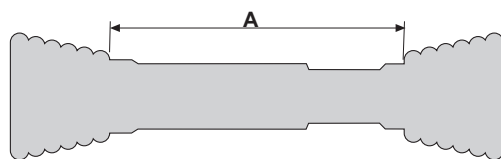

\*Kit Contains:  
2 each A=41mm / 1.63" ID Bearings,  
2 each S.56509 Nipple Locks

**Special Shaft Record**

**Assembled Couplings**

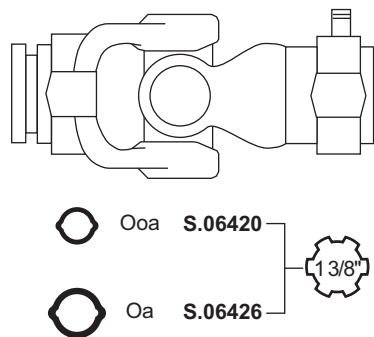

**Universal Joint**

**11**  
1 TYPE

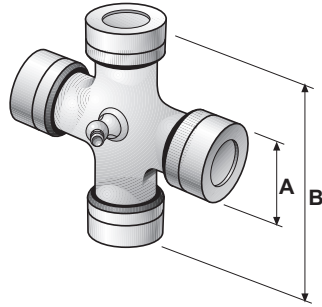

**S.02445**  
11.03.00  
A = 27mm 1 1/16"  
B = 70mm 2 3/4"

**Power-Torque Limit**

RPM	540 	1000 
h.p.	30	47

Values relate to continuous load, 5° working angle, 1000 hrs life.

**NOTE:** P.T.O. tubing is sold in 5 foot lengths. If a longer length is required order the same number without the (.5) and a 10 ft length will be shipped. **NOTE:** Truck shipments only.

**Q. R. Yokes**

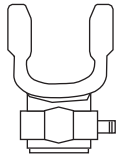

**S.06018**  
11.10.00

**S.06019**  
11.50.00

**Interfering Clamp Bolt Yokes**

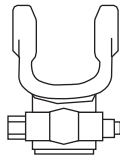

**S.07503**  
11.10.05

**S.07513**  
11.10.06

**Profile Tube Yokes**

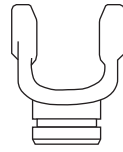

**S.06010**  
11.38.00

**S.06011**  
11.39.00

**Profile Tubes**  
(see note above)

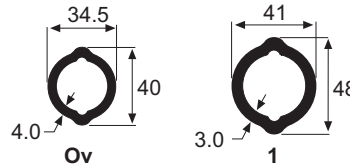

**S.04190.5**  
Ov

**S.04192.5**  
1

**Roll Pin**



**S.01235**  
10 x 65mm

**Slip Clutches Torque Limiter**



K32 600Nm **S.06629**  
5320 ins lbs (2 row)  
K33 900Nm **S.06635**  
7980 ins lbs (3 row)

**Shear Bolt Limiter**

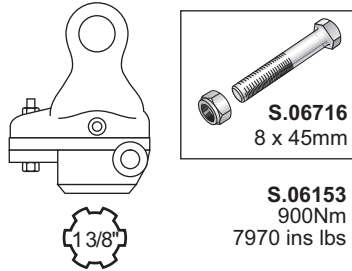

**S.06153**  
900Nm  
7970 ins lbs

**Free Wheel Overrunning Clutch**

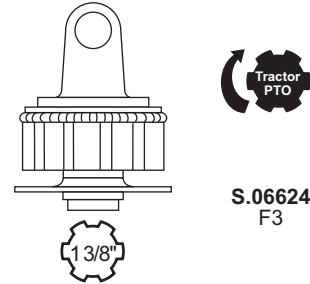

**S.06624**  
F3

**Keyway Yokes**

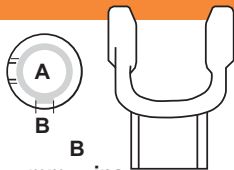

A		B		
mm	ins	mm	ins	
30	-	8	-	<b>S.06545</b>
35	-	10	-	<b>S.06546</b>
-	1"	-	1/4"	<b>S.06195</b>
-	1 1/4"	-	1/4"	<b>S.06196</b>
-	1 3/8"	-	1/4"	<b>S.06197</b>

**Pinhole Yokes**

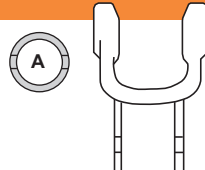

A		
mm	ins	
30	-	<b>S.06504</b>
35	-	<b>S.06505</b>
-	1"	<b>S.06125</b>
-	1 1/4"	<b>S.06127</b>

**Clamp Yokes**

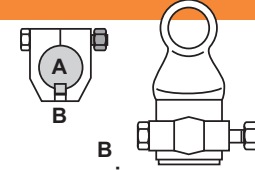

A		B		
mm	ins	mm	ins	
25	-	8	-	<b>S.06095</b>
30	-	8	-	<b>S.06096</b>
35	-	8	-	<b>S.06097</b>
-	1"	-	1/4"	<b>S.06067</b>
-	1 1/4"	-	1/4"	<b>S.06105</b>

### Complete Shafts & Guards

**Complete Shafts  
with 'Easy-Lock' Guards**  
conforming to CEN 1152



Min	A		Max	Shafts Ov/1
	mm	ins		
750	29"		1300	S.06606
1000	39"		1800	S.06607

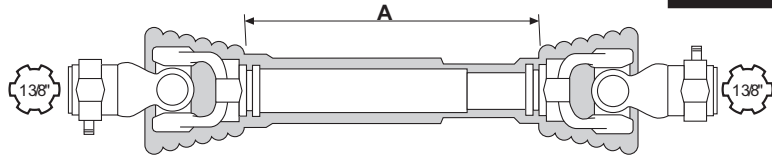

### 'Easy-Lock' Guards - 250

Ring Kit* S.59631 x2 50mm Ø	A		Guard	Nipple Lock S.56509
	mm	ins		
	750	29 1/2"	S.59605	
	1000	39 1/2"	S.59606	
	1300	51 1/2"	S.59607	

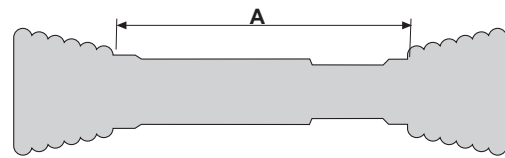

\*Kit Contains:  
2 each A=50mm / 2" ID Bearings,  
2 each S.56509 Nipple Locks

### Special Shaft Record

### Assembled Couplings

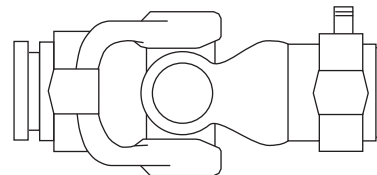

**Universal Joint**

**12**  
11 TYPE

**S.02446**

12.00.00

A = 34mm 1 11/32"

B = 90mm 3 17/32"

C = 50.5mm 2"

External Circlip

**S.14290**

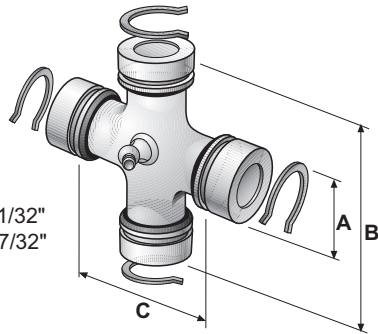

**Power-Torque Limit**

RPM	540 	1000 
h.p.	41	63

Values relate to continuous load, 5° working angle, 1000 hrs life.

**NOTE:** P.T.O. tubing is sold in 5 foot lengths. If a longer length is required order the same number without the (.5) and a 10 ft length will be shipped. **NOTE:** Truck shipments only.

**Q. R. Yokes**

**Interfering Clamp Bolt Yokes**

**Profile Tube Yokes**

**Profile Tubes**  
(see note above)

**Roll Pin**

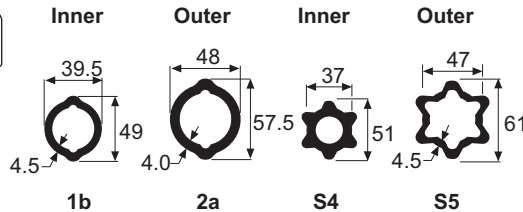
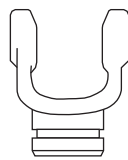
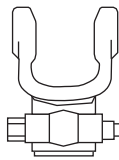
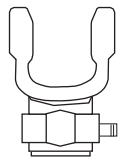

**S.06028**  
12.10.00



**S.07536**  
12.10.05



**S.06029**  
12.50.00



**S.07537**  
12.10.112



**S.06020**  
12.38.00



**S.06021**  
12.39.00



**S.06022**  
12.38.02



**S.06023**  
12.30.00

**S.04193.5**  
1b

**S.04194.5**  
2a

**S.04820.5**  
S4

**S.04821.5**  
S5

**S.01238**  
10 x 90mm

**Keyway Yokes**

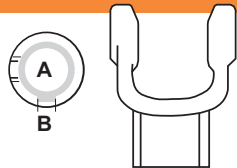

A		B		
mm	ins	mm	ins	
30	-	8	-	<b>S.06548</b>
35	-	10	-	<b>S.06549</b>
40	-	12	-	<b>S.06550</b>

**Pinhole Yokes**

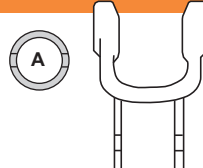

A		
mm	ins	
30	-	<b>S.06506</b>
35	-	<b>S.06507</b>
40	-	<b>S.06508</b>

**Clamp Yokes**

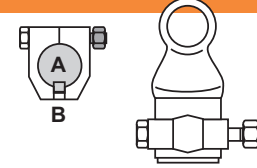

A		B		
mm	ins	mm	ins	
35	-	10	-	<b>S.06103</b>

**Complete Shafts & Guards**

**Complete Shafts**  
with 'Easy-Lock' Guards  
conforming to CEN 1152

**12**  
11 TYPE

Min		A		Max		Shafts 1b/2a
mm	ins	mm	ins	mm	ins	
750	29"	1300	51"			S.06611

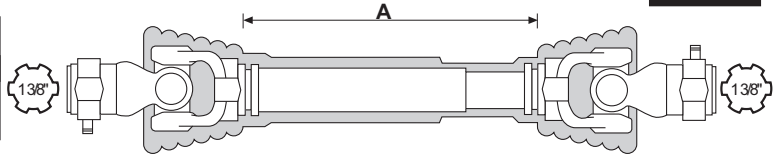

**'Easy-Lock' Guards - 350**

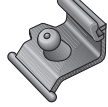
Ring Kit* S.59632 x2 63mm Ø 	A		Guard	Nipple Lock S.56509 
	mm	ins		
	750	29 1/2"	S.59613	
	1000	39 1/2"	S.59614	
	1300	51 1/2"	S.59615	

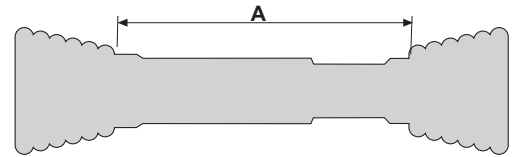



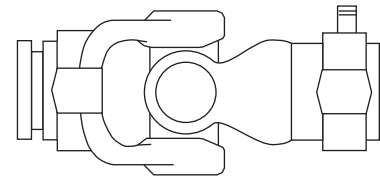

\*Kit Contains:  
2 each A=63mm / 2.46" ID Bearings,  
2 each S.56509 Nipple Locks

**Special Shaft Record**

**Assembled Couplings**



-  1b S.06422
  -  2a S.06428
  -  S4 S.06486
  -  S5 S.06487
-  13/8"



Universal Joint

**20**  
2200 TYPE

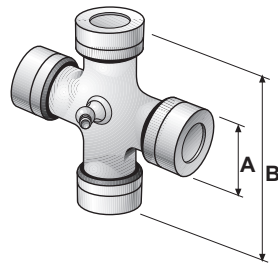

**S.02447**  
20.00.00  
A = 24mm 15/16"  
B = 61mm 2 13/32"

Power-Torque Limit

RPM	540 	1000 
h.p.	21	32

Values relate to continuous load, 5° working angle, 1000 hrs life.

**NOTE:** P.T.O. tubing is sold in 5 foot lengths. If a longer length is required order the same number without the (.5) and a 10 ft length will be shipped. **NOTE:** Truck shipments only.

Q. R. Yokes

Interfering Clamp Bolt Yokes

Profile Tube Yokes

Profile Tubes  
(see note above)

Roll Pin

<b>S.06038</b> 20.10.00	<b>S.07502</b> 20.10.02	<b>S.06030</b> 21.11.00	<b>S.04190.5</b> Ov		<b>S.01235</b> 10 x 65mm
<b>S.06039</b> 20.18.00	<b>S.07512</b> 20.10.119	<b>S.06031</b> 20.12.00		<b>S.04192.5</b> 1	
<b>S.03430</b> 20.27.00		<b>S.06032</b> 20.32.00		<b>S.04703.5</b> Ooa	<b>S.01228</b> 8 x 55mm
		<b>S.06033</b> 20.33.00			<b>S.04705.5</b> Oa

Slip Clutch Torque Limiter

K31 300Nm **S.06037**  
2660 ins lbs (1 row)

K32 600Nm **S.06036**  
5320 ins lbs (2 row)

K33 900Nm **S.06034**  
7980 ins lbs (3 row)

Shear Bolt Limiter

**S.06591**  
6 x 45mm

860Nm **S.06156**  
7610 ins lbs

Free Wheel Overrunning Clutch

F3 **S.06035**

**S.06212**

Keyway Yokes

A		B		
mm	ins	mm	ins	
20	-	6	-	<b>S.06551</b>
25	-	8	-	<b>S.06552</b>
30	-	8	-	<b>S.06553</b>
-	1"	-	1/4"	<b>S.06198</b>
-	1 1/4"	-	1/4"	<b>S.06199</b>
-	1 3/8"	-	5/16"	<b>S.06200</b>

Pinhole Yokes

A		
mm	ins	
20	-	<b>S.06509</b>
25	-	<b>S.06510</b>
30	-	<b>S.06511</b>
-	1"	<b>S.06133</b>
-	1 1/4"	<b>S.06134</b>
-	1 3/8"	<b>S.06014</b>

Clamp Yokes

A		B		
mm	ins	mm	ins	
25	-	8	-	<b>S.06106</b>
30	-	8	-	<b>S.06087</b>
-	1"	-	1/4"	<b>S.06295</b>
-	1 1/4"	-	1/4"	<b>S.06296</b>
-	1 3/8"	-	5/16"	<b>S.06297</b>

Complete Shafts & Guards

Complete Shafts with 'Easy-Lock' Guards conforming to CEN 1152



Min		A		Max		Shafts Ov/1
mm	ins	mm	ins	mm	ins	
750	29"	1300	51"			S.06616
1500	59"	2800	110"			S.06618

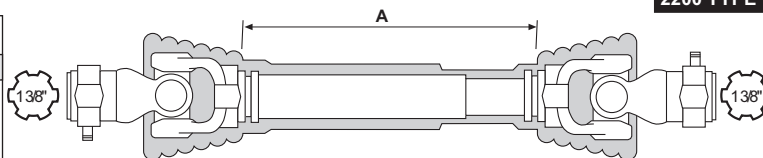

'Easy-Lock' Guards - 250

Ring Kit S.56500* 41mm Ø S.59631** 50mm Ø	A		Guard	Nipple Lock S.56509
	mm	ins		
	750	29 1/2"	S.59605	
	1000	39 1/2"	S.59606	
	1300	51 1/2"	S.56607	

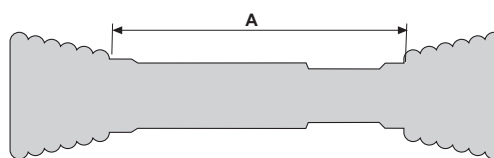

\*Kit Contains:

- 2 each A=50mm / 2" ID Bearings or
- 2 each A=41mm / 1.61" ID Bearings,
- 2 each S.56509 Nipple Locks

- \* Use with S.06032 & S.06033 Profile Yokes
- \*\*Use with S.06030 & S.06031 Profile Yokes

Special Shaft Record

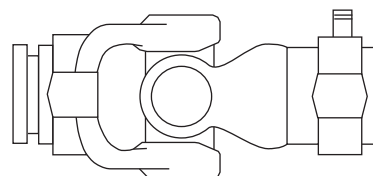

Assembled Couplings



- Ov S.06423
  - Ooa S.06488
  - 1 S.06429
  - Oa S.06489
-

**Universal Joint**

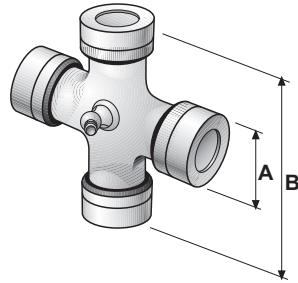
**21**  
2300 TYPE



**S.02448**  
21.00.00  
A = 27mm 1 1/16"  
B = 74.5mm 2 15/16"

**Power-Torque Limit**

RPM	540 	1000 
h.p.	29	45

Values relate to continuous load, 5° working angle, 1000 hrs life.

**NOTE:** P.T.O. tubing is sold in 5 foot lengths. If a longer length is required order the same number without the (.5) and a 10 ft length will be shipped. **NOTE:** Truck shipments only.

**Q. R. Yokes    Interfering Clamp Bolt Yokes    Profile Tube Yokes    Profile Tubes (see note above)    Roll Pin**

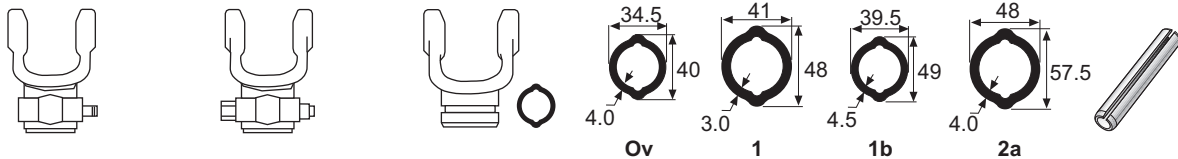

<b>S.06048</b> 21.10.00 	<b>S.07504</b> 21.29.00 	<b>S.06040</b> 21.11.00	<b>S.04190.5</b> Ov				<b>S.01235</b> 10 x 65mm
<b>S.06049</b> 21.19.00 	<b>S.07514</b> 21.10.110 	<b>S.06041</b> 21.12.00		<b>S.04192.5</b> 1			
		<b>S.06043</b> 21.22.100			<b>S.04193.5</b> 1b		<b>S.01237</b> 10 x 80mm
		<b>S.06042</b> 21.22.101				<b>S.04194.5</b> 2a	

**Slip Clutches Torque Limiter**



**S.06047**  
K32 600Nm  
5320 in/lbs (2 row)  
**S.06046**  
K33 900Nm  
7980 in/lbs (3 row)  
**S.06044**  
K34 1200 Nm  
10640 in/lbs (4 row)

**Shear Bolt Limiter**

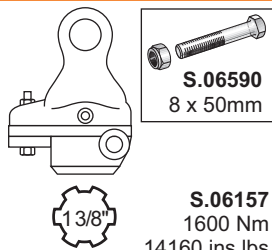

**S.06157**  
1600 Nm  
14160 ins lbs

**Free Wheel Overrunning Clutch**

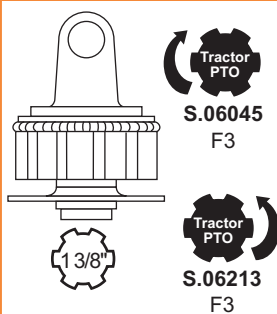

**S.06045**  
F3  
**S.06213**  
F3

**Friction Disc Clutch**

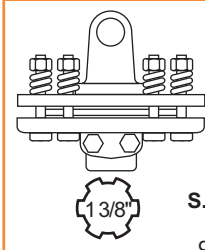

**S.06740**  
2 Disc  
900Nm  
7970 ins lbs

**Keyway Yokes**

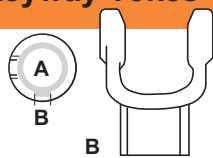

A	B	
mm	ins	mm ins
25	- 8	- <b>S.06554</b>
30	- 8	- <b>S.06555</b>
35	- 10	- <b>S.06556</b>
- 1"	- 1/4"	<b>S.06201</b>
- 1 1/4"	- 1/4"	<b>S.06202</b>
- 1 3/8"	- 5/16"	<b>S.06203</b>

**Pinhole Yokes**

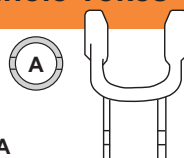

A		
mm	ins	
25	-	<b>S.06513</b>
30	-	<b>S.06514</b>
35	-	<b>S.06515</b>
- 1"		<b>S.06136</b>
- 1 1/4"		<b>S.06137</b>
- 1 3/8"		<b>S.06142</b>

**Clamp Yokes**

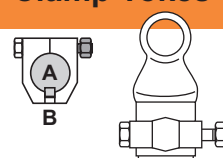

A	B	
mm	ins	mm ins
30	- 8	- <b>S.06108</b>
35	- 10	- <b>S.06109</b>
- 1"	- 1/4"	<b>S.06107</b>
- 1 1/4"	- 1/4"	<b>S.06135</b>

**Assembled Couplings**

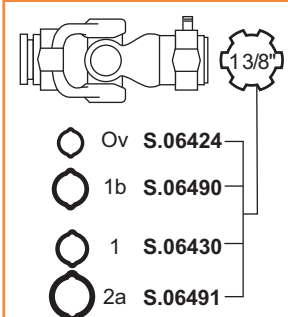

Ov	<b>S.06424</b>
1b	<b>S.06490</b>
1	<b>S.06430</b>
2a	<b>S.06491</b>

**Complete Shafts & Guards**

**Complete Shafts  
with 'Easy-Lock' Guards  
conforming to CEN 1152**

**21**  
2300 TYPE

Min		A		Max		Shafts
mm	ins	mm	ins	mm	ins	
1000	39"	1800	71"			Ov/1 S.01571

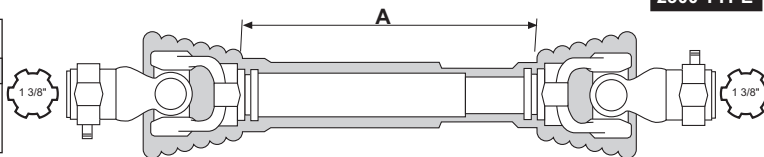

**'Easy-Lock' Guards - 250**

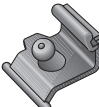
Ring Kit* S.59631 50mm Ø X2 	A		Guard	Nipple Lock S.56509 
	mm	ins		
	750	29 1/2"	S.59605	
	1000	39 1/2"	S.59606	
	1300	51 1/2"	S.59607	

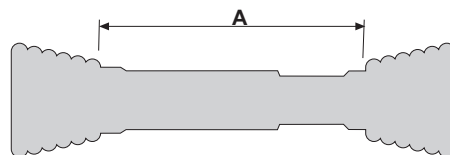

\*Kit Contains: 2 each A= 50mm / 2" ID Bearings,  
2 each S.56509 Nipple Locks  
Fits: S.06040, S.06041 Yokes

**'Easy-Lock' Guards - 350**

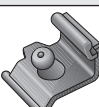
Ring Kit* S.59632 63mm Ø X2 	A		Guard	Nipple Lock S.56509 
	mm	ins		
	750	29 1/2"	S.59613	
	1000	39 1/2"	S.59614	
	1500	51 1/2"	S.59615	

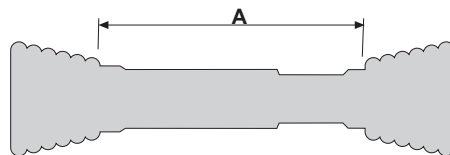

\*Kit Contains: 2 each A=63mm / 2.46" ID Bearings,  
2 each S.56509 Nipple Locks  
Fits: S.06042, S.06043 Yokes

Universal Joint

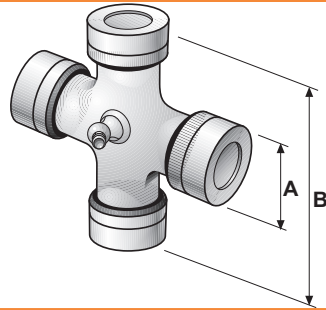

**S.02449**  
22.00.00  
A = 30mm 1 3/16"  
B = 92mm 3 5/8"

Power-Torque Limit

RPM	540 	1000 
h.p.	60	98

Values relate to continuous load, 5° working angle, 1000 hrs life.

**NOTE:** P.T.O. tubing is sold in 5 foot lengths. If a longer length is required order the same number without the (.5) and a 10 ft length will be shipped. **NOTE:** Truck shipments only.

Q. R. Yokes

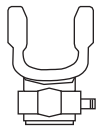

<b>S.06058</b> 22.10.00	
<b>S.06059</b> 22.19.00	
<b>S.06522</b> 22.18.00	
<b>S.14430</b> 22.18.12	

Interfering Clamp Bolt Yokes

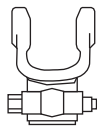

<b>S.07506</b> 22.10.02	
<b>S.07516</b>	
<b>S.07526</b> 22.18.02	

Profile Tube Yokes

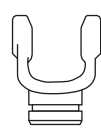

<b>S.06050</b> 22.11.00	
<b>S.06051</b> 22.12.00	
<b>S.06052</b> 22.11.01	
<b>S.06053</b> 22.30.00	

Profile Tubes  
(see note above)

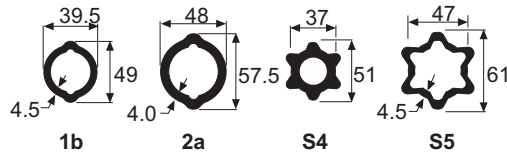

<b>S.04193.5</b> 1	<b>S.04194.5</b> 2a	<b>S.04820.5</b> S4	<b>S.04821.5</b> S5
-----------------------	------------------------	------------------------	------------------------

Roll Pin



**S.01237**  
10 x 80mm

Slip Clutch Torque Limiter

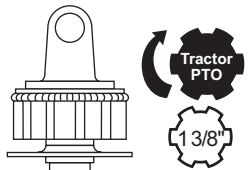

K33 900Nm **S.06057**  
7980 ins lbs (3 row)  
K34 1200 Nm **S.06056**  
10640 ins lbs (4 row)

Shear Bolt Limiter

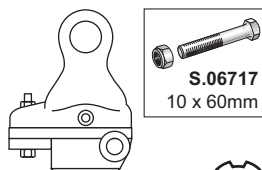

2400 Nm **S.06158**   
21240 ins lbs **S.06298**

Free Wheel Overrunning Clutch



**S.06055**  
F3   
**S.06210**

Friction Disc Clutch

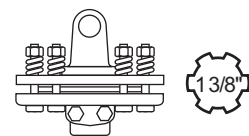

2 Disc **S.06742**  
10620 ins/1200NM  
4 Disc **S.06743**  
15930 ins lbs/1800NM

Keyway Yokes

A		B		
mm	ins	mm	ins	
30	-	8	-	<b>S.06558</b>
32	-	9	-	<b>S.06571</b>
35	-	10	-	<b>S.06559</b>
40	-	12	-	<b>S.06560</b>
-	1 1/4"	-	5/16"	<b>S.06204</b>
-	1 3/8"	-	5/16"	<b>S.06205</b>
-	1 1/2"	-	3/8"	<b>S.06206</b>

Pinhole Yokes

A		
mm	ins	
30	-	<b>S.06516</b>
35	-	<b>S.06517</b>
40	-	<b>S.06518</b>
-	1 1/4"	<b>S.06143</b>
-	1 3/8"	<b>S.06144</b>
-	1 1/2"	<b>S.06145</b>

Clamp Yokes

A		B		
mm	ins	mm	ins	
30	-	8	-	<b>S.06113</b>
35	-	10	-	<b>S.06114</b>
40	-	12	-	<b>S.06115</b>
-	1 1/4"	-	5/16"	<b>S.06282</b>
-	1 3/8"	-	5/16"	<b>S.06151</b>
-	1 1/2"	-	3/8"	<b>S.06152</b>

Complete Shafts & Guards

Complete Shafts  
with 'Easy-Lock' Guards  
conforming to CEN 1152



Min		A		Max		Shafts
mm	ins	mm	ins	mm	ins	
500	20"	800	31"			1b/2a S.06625

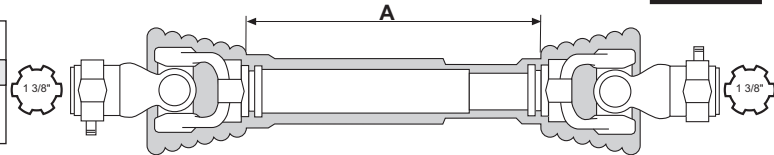

'Easy-Lock' Guards - 350

Ring Kit* S.59632 x2 63mm Ø	A		Guard	Nipple Lock S.56509
	mm	ins		
	750	29 1/2"	S.59613	
	1000	39 1/2"	S.59614	
	1300	51 1/2"	S.59615	

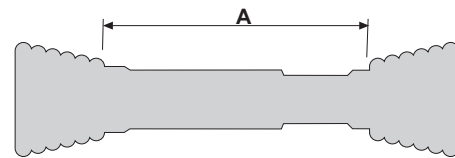

\*Kit Contains: 2 each A=63mm / 2.46" ID Bearings,  
2 each S.56509 Nipple Locks

Special Shaft Record

Assembled Couplings

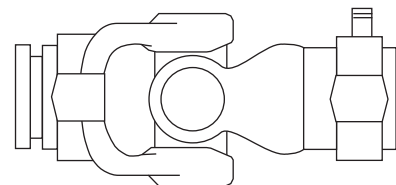

- 1b S.06425
- 2a S.06431
- S4 S.06492
- S5 S.06493



**Universal Joint**

**24**  
240 TYPE

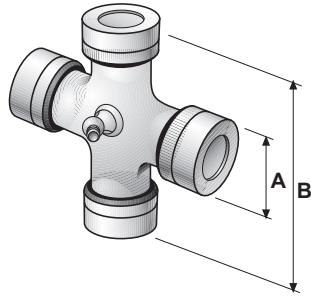

**S.02496**  
24.01.00  
A = 35mm 1 3/8"  
B = 106.5mm 4 3/16"

**Power-Torque Limit**

RPM	540 	1000 
h.p.	92	147

Values relate to continuous load, 5° working angle, 1000 hrs life.

**NOTE:** P.T.O. tubing is sold in 5 foot lengths. If a longer length is required order the same number without the (.5) and a 10 ft length will be shipped. **NOTE:** Truck shipments only.

**Q. R. Yokes**

**Interfering Clamp Bolt Yokes**

**Profile Tube Yokes**

**Profile Tubes**  
(see note above)

**Roll Pin**

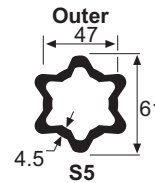
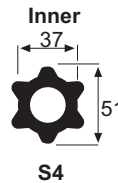
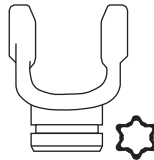
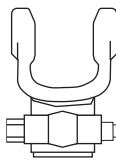
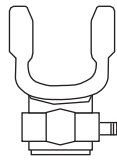

<b>S.06068</b> 24.10.00	
<b>S.06069</b> 24.18.00	
<b>S.06523</b> 24.17.00	
<b>S.14431</b> 24.17.06	

<b>S.07508</b> 24.10.03	
<b>S.07518</b>	
<b>S.07528</b> 24.17.02	

<b>S.06060</b> 24.11.00
<b>S.06061</b> 24.12.00

<b>S.04820.5</b> S4
<b>S.04821.5</b> S5

<b>S.01172</b> 1/2" x 3 1/2"
---------------------------------

**Shear Bolt Limiter**

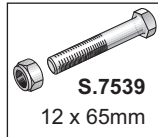
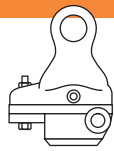

	3400Nm 30000 ins lbs	<b>S.07538</b>
	2920Nm 25760 ins lbs	<b>S.06266</b>

**Friction Disc Clutch**

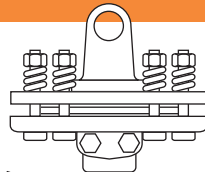

	<b>S.06744</b>	4 Disc 2000 Nm 17700 ins lbs
	<b>S.06732</b>	

**Free Wheel Overrunning Clutch**



	<b>S.06749</b> F3
--	----------------------

**Keyway Yokes**

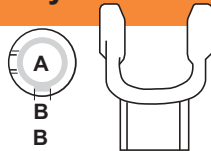

A		B		
mm	ins	mm	ins	
35	-	10	-	<b>S.06561</b>
40	-	12	-	<b>S.06722</b>
-	1 1/2"	-	3/8"	<b>S.06207</b>
-	1 5/8"	-	3/8"	<b>S.06208</b>

**Pinhole Yokes**

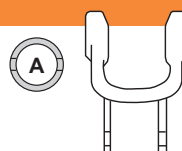

A		
mm	ins	
35	-	<b>S.06519</b>
40	-	<b>S.06721</b>
-	1 1/2"	<b>S.06146</b>
-	1 5/8"	<b>S.06147</b>

**Clamp Yokes**

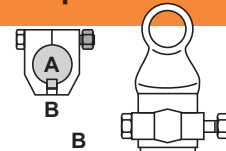

A		B		
mm	ins	mm	ins	
10	-	35	-	<b>S.06116</b>
12	-	40	-	<b>S.06117</b>
-	1 1/2"	-	3/8"	<b>S.06286</b>
-	1 5/8"	-	3/8"	<b>S.06287</b>

Complete Shafts & Guards

Complete Shafts with 'Easy-Lock' Guards conforming to CEN 1152

**24**  
240 TYPE

Min		A		Max		Shafts
mm	ins	mm	ins	mm	ins	
1000	39"	1800	71"			S4/S5 S.06632

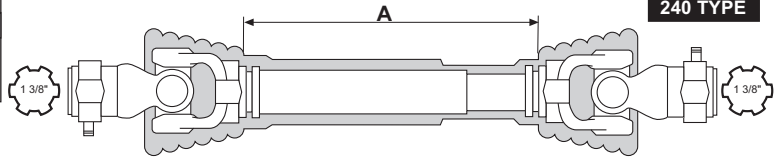

'Easy-Lock' Guards - 350

Ring Kit* S.59632 x2 63mm Ø	A		Guard	Nipple Lock S.56509
	mm	ins		
	750	29 1/2"	S.59613	
	1000	39 1/2"	S.59614	
	1300	51 1/2"	S.59615	

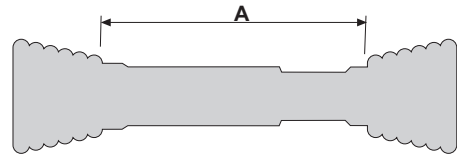

\*Kit Contains: 2 each A=63mm / 2.46" ID Bearings, 2 each S.56509 Nipple Locks

Assembled Couplings

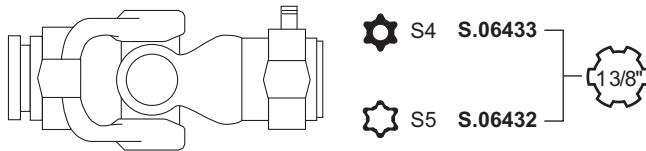

Universal Joint

**26**  
2600 TYPE

S.06452  
26.00.00  
A = 42mm  
B = 104mm

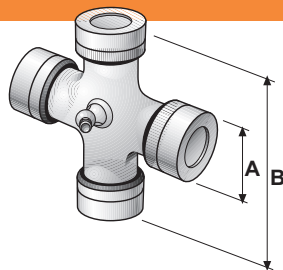

Power-Torque Limit

RPM	540	1000
h.p	106	163

Values relate to continuous load, 5° working angle, 1000 hrs life.

Q. R. Yokes

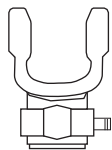

S.07561  
26.10.00

S.07562  
26.10.02

Profile Tube Yokes

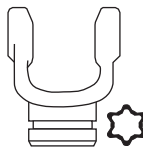

S.07563  
26.13.00

S.07564  
26.14.100

Profile Tubes

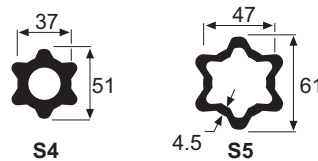

S.04820.5  
S4

S.04821.5  
S5

Roll Pin

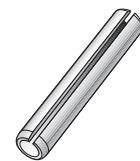

S.01238  
10 x 90mm

S.11487  
13 x 90mm



Universal Joint

**35**  
2400 TYPE

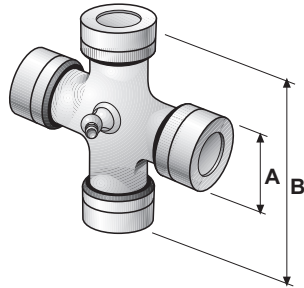

**S.06450**  
35.00.00  
A = 32mm 1 1/4"  
B = 76mm 2 31/32"

Power-Torque Limit

RPM	540	1000
h.p.	40	60

Values relate to continuous load, 5° working angle, 1000 hrs life.

**NOTE:** P.T.O. tubing is sold in 5 foot lengths. If a longer length is required order the same number without the (.5) and a 10 ft length will be shipped. **NOTE:** Truck shipments only.

Q. R. Yokes

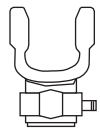

**S.06078**   
35.10.00  
**S.06079**   
35.10.02  
**S.06521**   
35.18.00  
**S.06280**   
35.18.02

Interfering Clamp Bolt Yokes

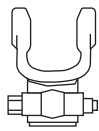

**S.07521**   
35.10.04  
**S.07523**   
35.10.06  
**S.07531**   
35.18.04

Profile Tube Yokes

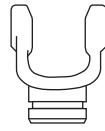

**S.06072**   
35.13.00  
**S.06073**   
35.14.00  
**S.06074**   
35.13.100  
**S.06075**   
35.14.100

Profile Tubes (see note above)

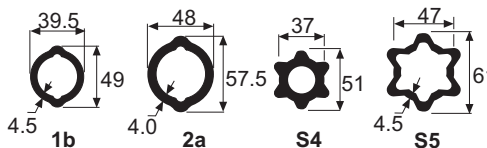

<b>S.04193.5</b> 1b			
	<b>S.04194.5</b> 2a		
		<b>S.04820.5</b> S4	
			<b>S.04821.5</b> S5

Roll Pin



**S.01237**  
10 x 80mm

Slip Clutches Torque Limiter



K33 802Nm **S.06076**  
6950 ins lbs (3 row)  
K34 1069 Nm **S.06077**  
9260 ins lbs (4 row)

Shear Bolt Limiter

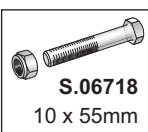

**S.06718**  
10 x 55mm  
  
**S.06154**  
1330 Nm  
11790 ins lbs

Free Wheel Overrunning Clutch

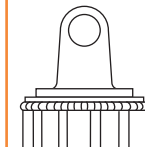

**S.06720**  
F5/1



**S.06214**

Friction Disc Clutch

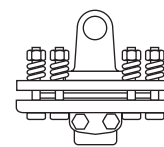

2 Disc **S.06448**  
900Nm  
7970 ins lbs

Keyway Yokes

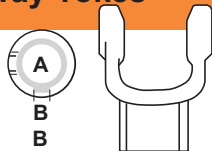

A		B		
mm	ins	mm	ins	
35	-	10	-	<b>S.06726</b>
40	-	12	-	<b>S.06727</b>
-	1 1/4"	-	5/16"	<b>S.06251</b>
-	1 3/8"	-	3/8"	<b>S.06252</b>

Pinhole Yokes

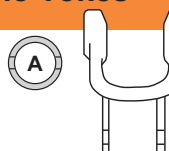

A		
mm	ins	
35	-	<b>S.06724</b>
40	-	<b>S.06725</b>
-	1 1/4"	<b>S.06148</b>
-	1 3/8"	<b>S.06149</b>

Clamp Yokes

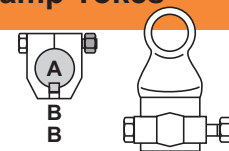

A		B		
mm	ins	mm	ins	
35	-	10	-	<b>S.06253</b>
40	-	12	-	<b>S.06254</b>
-	1 1/2"	-	3/8"	<b>S.06288</b>
-	1 3/8"	-	3/8"	<b>S.06289</b>

Complete Shafts & Guards

**Complete Shafts  
with 'Easy-Lock' Guards  
conforming to CEN 1152**

**35**  
2400 TYPE

Min		A		Max		Shafts
mm	ins	mm	ins	mm	ins	
780	31.75"	1360	53.5"			1b/2a S.01573

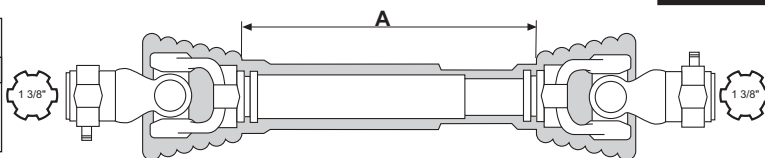

**'Easy-Lock' Guards - 350**

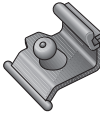
Ring Kit* S.59632 x2 63mm Ø	A		Guard	Nipple Lock S.56509
	mm	ins		
	750	29 1/2"	S.59613	
	1000	39 1/2"	S.59614	
	1300	51 1/2"	S.59615	

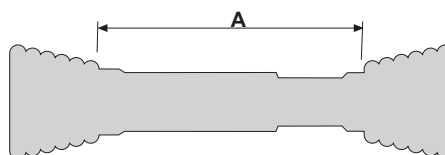

\*Kit Contains: 2 each A=63mm / 2.46" ID Bearings,  
2 each S.56509 Nipple Locks

**Special Shaft Record**

**Assembled Couplings**

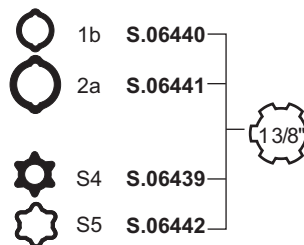
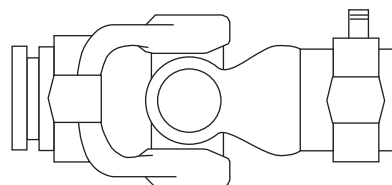

**Universal Joint**

**36**

**2500 TYPE**

**S.06451**  
36.00.00

A = 36mm 1 13/32"  
B = 89mm 3 1/2"

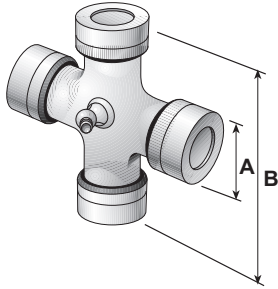

**Power-Torque Limit**

RPM	540 	1000 
h.p.	68	105

Values relate to continuous load, 5° working angle, 1000 hrs life.

**NOTE:** P.T.O. tubing is sold in 5 foot lengths. If a longer length is required order the same number without the (.5) and a 10 ft length will be shipped. **NOTE:** Truck shipments only.

**Q. R. Yokes**

**Interfering Clamp Bolt Yokes**

**Profile Tube Yokes**

**Profile Tubes**  
(see note above)

**Roll Pin**

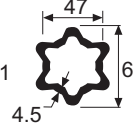
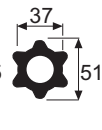
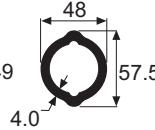
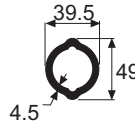
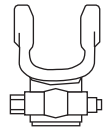
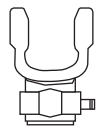

<b>S.06088</b> 36.10.00	
<b>S.06089</b> 36.10.02	
<b>S.06534</b> 36.18.00	
<b>S.06535</b> 36.18.02	

<b>S.07522</b> 36.10.08	
<b>S.07524</b> 36.10.06	
<b>S.07532</b> 36.18.04	

<b>S.06082</b> 36.13.00	
<b>S.06083</b> 36.14.00	
<b>S.06084</b> 36.13.100	
<b>S.06085</b> 36.14.100	

<b>S.04193.5</b> 1b	
<b>S.04194.5</b> 2a	

<b>S.04820.5</b> S4	
<b>S.04821.5</b> S5	

**S.01238**  
10 x 90mm

**Shear Bolt Limiter**

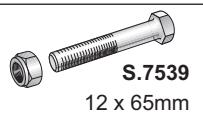
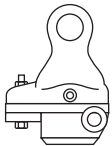

	2920 Nm 25840 ins lbs	<b>S.06262</b>
	3800 Nm 33630 ins lbs	<b>S.06263</b>

**Friction Disc Clutch**

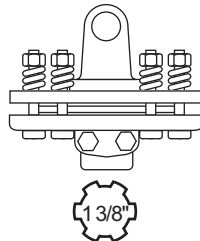

**S.06737**  
4 Disc  
2000Nm  
17700 ins lbs

**Assembled Couplings**

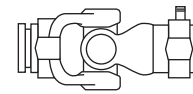

	1b	<b>S.06496</b>
	2a	<b>S.06497</b>
	S4	<b>S.06498</b>
	S5	<b>S.06499</b>

Complete Shafts & Guards

Complete Shafts  
with 'Easy-Lock' Guards  
conforming to CEN 1152



Min		A		Max		Shafts
mm	ins	mm	ins	mm	ins	
750	29"	1300	51"	1b/2a		S.06746

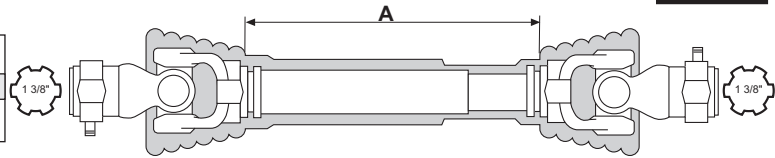

'Easy-Lock' Guards - 350

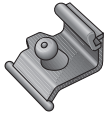
Ring Kit* S.59632 x2 63mm Ø 	A		Guard	Nipple Lock S.56509 
	mm	ins		
	750	29 1/2"	S.59613	
	1000	39 1/2"	S.59614	
	1300	51 1/2"	S.59615	

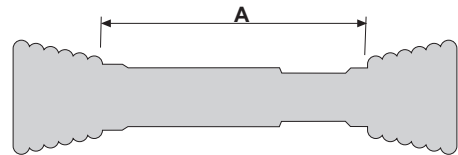

\*Kit Contains: 2 each A=63mm / 2.46" ID Bearings,  
2 each S.56509 Nipple Locks

Special Shaft Record

**Universal Joint**



**S.02498**  
1.41  
41201  
A = 22mm 7/8"  
B = 54mm 2 1/32"

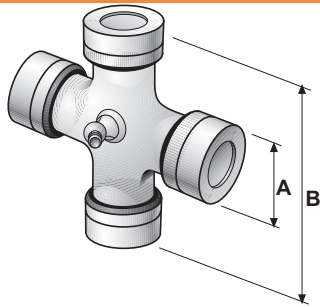

**Power-Torque Limit**

RPM	540 	1000 
h.p.	16	25

Values relate to continuous load, 5° working angle, 1000 hrs life.

**NOTE:** P.T.O. tubing is sold in 5 foot lengths. If a longer length is required order the same number without the (.5) and a 10 ft length will be shipped. **NOTE:** Truck shipments only.

**Q. R. Yokes**

**Interfering Clamp Bolt Yokes**

**Profile Tube Yokes**

**Profile Tubes**  
(see note above)

**Roll Pin**

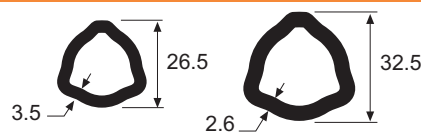
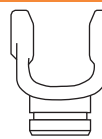
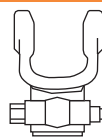
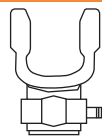

<b>S.06008</b> 1.05.07	
<b>S.06009</b> 1.05.08	
<b>S.06004</b> 1.05.03	

<b>S.07501</b> 1.05.17 509010352	
<b>S.07511</b> 1.05.18 509013751	

<b>S.06070</b> 1.07 204016852	
<b>S.06071</b> 1.06 204016851	

<b>S.04811.5</b> 1.04 12505
-----------------------------------

<b>S.04810.5</b> 1.03 12503
-----------------------------------

<b>S.01207</b> 8 x 50mm
----------------------------

**Slip Clutches Torque Limiter**

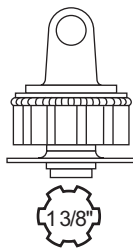

**S.06006**  
K31 300NM  
2660 in/lb (1 row)

**S.06007**  
K32 600NM  
5320 in/lb (2 row)

**Shear Bolt Limiter**

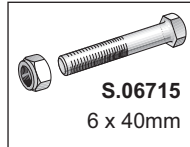
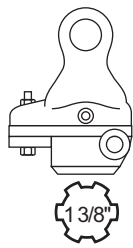

**S.06715**  
6 x 40mm

**S.06155**  
630Nm  
5580 ins lbs

**Free Wheel Overrunning Clutch**

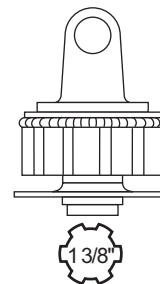

**S.06005**  
RA1



**S.06211**

**Keyway Yokes**

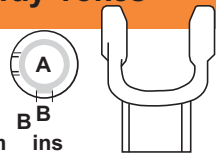

A		B		
mm	ins	mm	ins	
20	-	6	-	<b>S.06540</b>
25	-	8	-	<b>S.06541</b>
30	-	8	-	<b>S.06542</b>
35	-	10	-	<b>S.06503</b>
-	1"	-	1/4"	<b>S.06192</b>
-	1 1/8"	-	1/4"	<b>S.06193</b>
-	1 1/4"	-	1/4"	<b>S.06194</b>

**Pinhole Yokes**

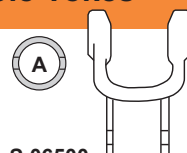

A		
mm	ins	
20	-	<b>S.06500</b>
25	-	<b>S.06501</b>
30	-	<b>S.06502</b>
-	1"	<b>S.06122</b>
-	1 1/8"	<b>S.06123</b>
-	1 1/4"	<b>S.06124</b>
-	1 3/8"	<b>S.06015</b>

**Clamp Yokes**

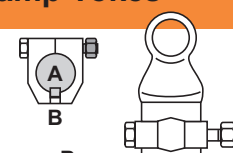

A		B		
mm	ins	mm	ins	
25	-	8	-	<b>S.06093</b>
30	-	8	-	<b>S.06094</b>
-	1"	-	1/4"	<b>S.06259</b>
-	1 1/8"	-	1/4"	<b>S.06065</b>
-	1 1/4"	-	1/4"	<b>S.06066</b>

Complete Shafts & Guards

Complete Shafts  
with 'Easy-Lock' Guards  
conforming to CEN 1152



Min		A		Max		Shafts
mm	ins	mm	ins	mm	ins	
320	12.5"	440	17.5"			S.61036*
620	20"	1040	41"			S.13492*
820	29"	1440	56.5"			S.13493*

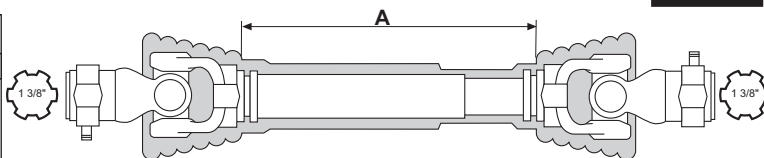

'Easy-Lock' Guards - 250

Ring Kit* S.56550 x2 34, 40mm Ø	A		Guard	Nipple Lock S.56509
	mm	ins		
	750	29 1/2"	S.59605	
	1000	39 1/2"	S.59606	
	1300	51 1/2"	S.59607	

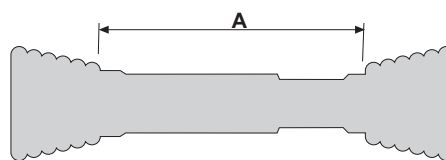

\*Kit Contains: 1x A=34mm Bearing,  
1x A=40mm Bearing,  
2 each S.56509 Nipple Locks

\*Featured Driveshaft have special pricing

Special Shaft Record

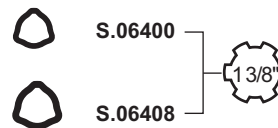
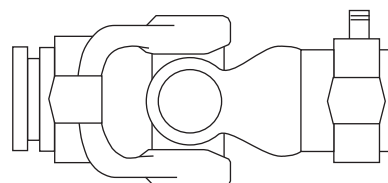

Assembled Couplings



Universal Joint

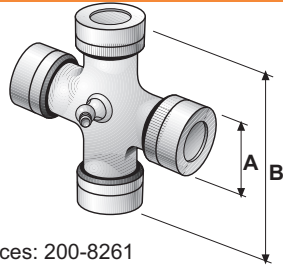

S.02447  
S.72447\*  
A = 24mm (15/16")  
B = 61mm (2 13/32")  
2.41 41202



Replaces: 200-8261

\*Can be used on shafts subjected to continuous heavy loads and/or high speeds where premature UJ failure may occur.

Power-Torque Limit

RPM	540 	1000 
h.p.	21	31

Values relate to continuous load, 5° working angle, 1000 hrs life.

**NOTE:** P.T.O. tubing is sold in 5 foot lengths. If a longer length is required order the same number without the (.5) and a 10 ft length will be shipped. **NOTE:** Truck shipments only.

Q. R. Yokes

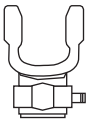

S.06038  
2.05.07   
507020351

S.06039  
2.05.08   
507023751

S.03430  
2.05.03   
507020151

Interfering Clamp Bolt Yokes

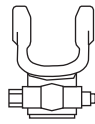

S.07502  
2.05.17   
509020352

S.07512  
2.05.18   
509023751

Profile Tube Yokes



S.06080  
2.07  
204026852

S.06081  
2.06  
204026851

Profile Tubes  
(see note above)

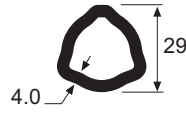

S.04813.5  
2.04  
12504

S.04812.5  
2.03  
12505

Roll Pin



S.01228  
8 x 55mm

Slip Clutches  
Torque Limiter

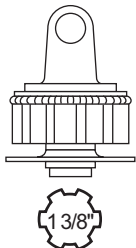

K31 300 Nm S.06037  
2660 ins lbs (1 row)

K32 600Nm S.06036  
5320 ins lbs (2 row)

K33 900Nm S.06034  
7980 ins lbs (3 row)

Shear Bolt Limiter

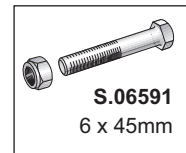
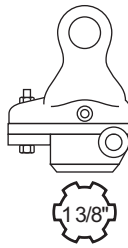

S.06156  
860Nm  
7610 ins lbs

Free Wheel  
Overrunning Clutch

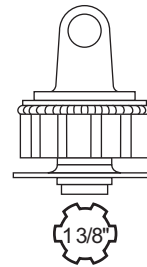

S.06035  
RA1

S.06212

Keyway Yokes

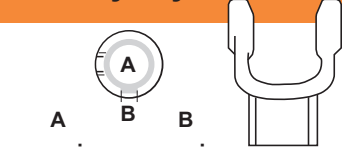

A		B		
mm	ins	mm	ins	
20	-	6	-	S.06551
25	-	8	-	S.06552
30	-	8	-	S.06553
-	1"	-	1/4"	S.06198
-	1 1/4"	-	1/4"	S.06199
-	1 3/8"	-	5/16"	S.06200

Pinhole Yokes

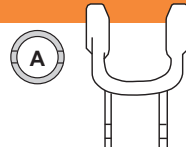

A		
mm	ins	
20	-	S.06509
25	-	S.06510
30	-	S.06511
-	1"	S.06133
-	1 1/4"	S.06134
-	1 3/8"	S.06014

Clamp Yokes

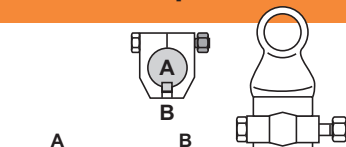

A		B		
mm	ins	mm	ins	
25	-	8	-	S.06106
30	-	8	-	S.06087
-	1"	-	1/4"	S.06295
-	1 1/4"	-	1/4"	S.06296
-	1 3/8"	-	5/16"	S.06297

Complete Shafts & Guards

**Complete Shafts  
with 'Easy-Lock' Guards**  
conforming to CEN 1152



mm	A		mm	ins	Shafts
	Min	Max			
420	16.5"	640	25.25"		S.04634*
750	29"	1300	51"		S.06686
820	32.5"	1440	56.5"		S.04635

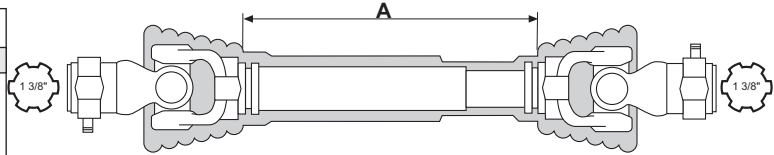

**'Easy-Lock' Guards - 250**

Ring Kit* S.59635 40mm Ø x1 47mm Ø x1	A		Guard	Nipple Lock S.56509
	mm	ins		
	750	29 1/2"	S.59605	
	1000	39 1/2"	S.59606	
	1300	51 1/2"	S.59607	

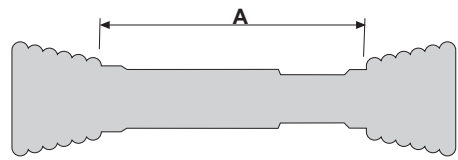

\*Kit Contains: 1x A=40mm Bearing,  
1x A=47mm Bearing,  
2 each S.56509 Nipple Locks

\*Featured Driveshaft have special pricing

Special Shaft Record

Assembled Couplings

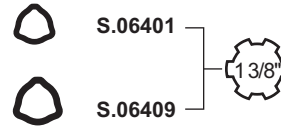
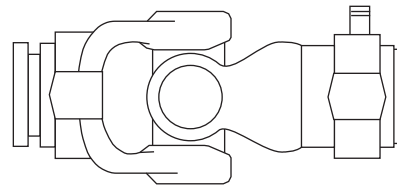



Universal Joint



S.02445  
S.72445\*  
3.41  
41203  
A = 27mm 1 1/16"  
B = 70mm 2 3/4"

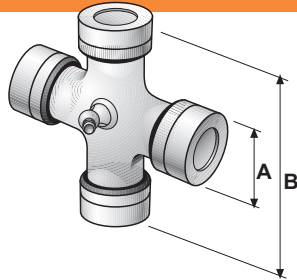

\*Can be used on shafts subjected to continuous heavy loads and/or high speeds where premature UJ failure may occur.

Power-Torque Limit

RPM	540 	1000 
h.p.	30	47

Values relate to continuous load, 5° working angle, 1000 hrs life.

**NOTE:** P.T.O. tubing is sold in 5 foot lengths. If a longer length is required order the same number without the (.5) and a 10 ft length will be shipped. **NOTE:** Truck shipments only.

Q. R. Yokes

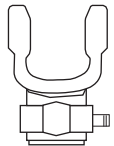

S.06018  
3.05.07  
507030351

S.06019  
3.05.08  
507033751

Interfering Clamp Bolt Yokes

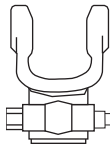

S.07503  
3.05.17  
509030352

S.07513  
3.05.18  
509033752

Profile Tube Yokes

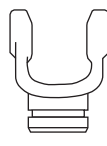

S.60090  
3.07  
204036852

S.06091  
3.06  
204036851

Profile Tubes  
(see note above)

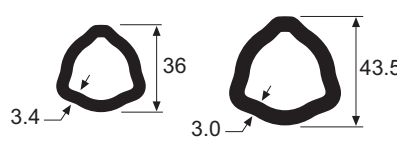

S.04812.5  
2.03  
12505

S.04814.5  
3.03  
12508

Roll Pin



S.01230  
8 x 70mm

Slip Clutches  
Torque Limiter

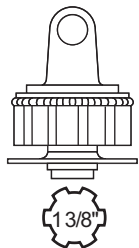

K32 600Nm S.06629  
5320 ins lbs (2 row)  
K33 900Nm S.06635  
7980 ins lbs (3 row)

Shear Bolt Limiter

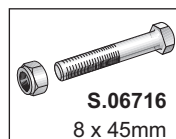
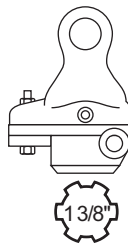

S.06716  
8 x 45mm

S.06153  
900Nm  
7970 ins lbs

Free Wheel  
Overrunning Clutch

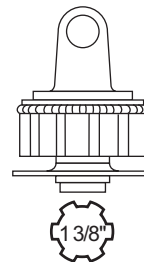

S.06624  
F3

Keyway Yokes

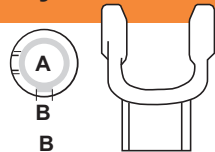

A		B		
mm	ins	mm	ins	
30	-	8	-	S.06545
35	-	10	-	S.06546
-	1"	-	1/4"	S.06195
-	1 1/4"	-	1/4"	S.06196
-	1 3/8"	-	1/4"	S.06197

Pinhole Yokes

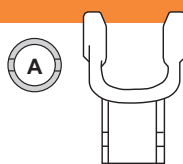

A		
mm	ins	
30	-	S.06504
35	-	S.06505
-	1"	S.06125
-	1 1/4"	S.06127

Clamp Yokes

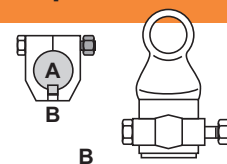

A		B		
mm	ins	mm	ins	
25	-	6	-	S.06095
30	-	8	-	S.06096
35	-	8	-	S.06097
-	1"	-	1/4"	S.06067
-	1 1/4"	-	1/4"	S.06105

Complete Shafts & Guards

Complete Shafts  
with 'Easy-Lock' Guards  
conforming to CEN 1152



Min		A		Max		Shafts
mm	ins	mm	ins	mm	ins	
750	29"	1300	51"			S.06691

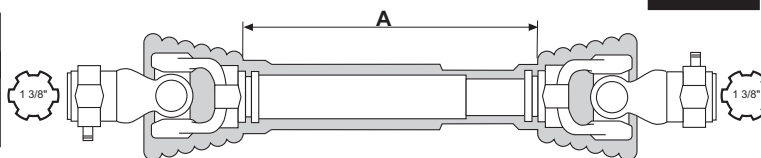

'Easy-Lock' Guards - 250

Ring Kit* S.59636 47mm Ø x1 54mm Ø x1	A		Guard	Nipple Lock S.56509
	mm	ins		
	750	29.5"	S.59605	
	1000	39.5"	S.59606	
	1300	51.5"	S.59607	

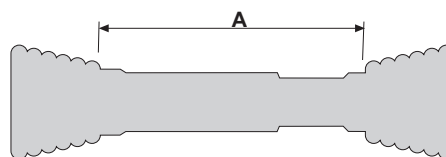

\*Kit Contains: 1x A=47mm Bearing,  
1x A=54mm Bearing,  
2 each S.56509 Nipple Locks

Special Shaft Record

Assembled Couplings

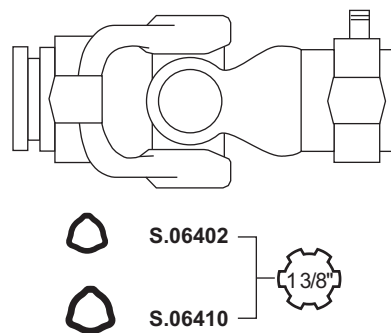

**Universal Joint**



**S.02448**  
4.41  
41204

A = 27mm 1 1/16"  
B = 74.5mm 2 15/16"

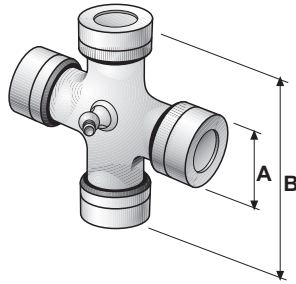

**Power-Torque Limit**

RPM	540 	1000 
h.p.	35	55

Values relate to continuous load, 5° working angle, 1000 hrs life.

**NOTE:** P.T.O. tubing is sold in 5 foot lengths. If a longer length is required order the same number without the (.5) and a 10 ft length will be shipped. **NOTE:** Truck shipments only.

**Q. R. Yokes**

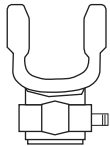

**S.06048**  
4.05.07  
507040351



**S.06049**  
4.05.08  
507043751



**Interfering Clamp Bolt Yokes**

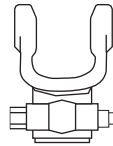

**S.07504**  
4.05.17  
509040352



**S.07514**  
4.05.18  
509043751



**Profile Tube Yokes**

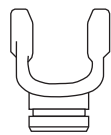

**S.06100**  
4.07  
204046852



**S.06101**  
4.06  
204046851

**Profile Tubes**  
(see note above)

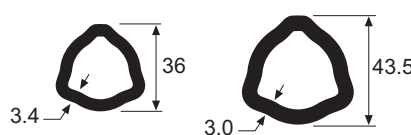

**S.04815.5**  
4.03  
12507

**S.04814.5**  
4.03  
12508

**Roll Pin**



**S.01230**  
8 x 70mm

**Slip Clutches Torque Limiter**



K32 600Nm  
53200 ins lbs (2 row)  
K33 900Nm  
7980 ins lbs (3 row)  
K34 1200Nm  
10640 ins lbs (4 row)

**S.06047**

**S.06046**

**S.06044**

**Shear Bolt Limiter**

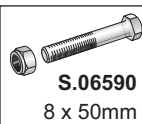

**S.06590**  
8 x 50mm

**S.06157**  
1600 Nm  
14160 ins lbs



**Free Wheel Overrunning Clutch**



**S.06045**  
RA1



**S.06213**

**Friction Disc Clutch**

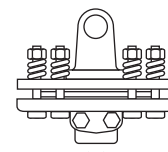

Disc  
900Nm  
7970 ins lbs

**S.06740**

**Keyway Yokes**

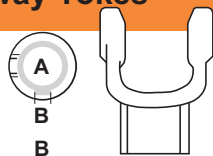

A		B		
mm	ins	mm	ins	
25	-	8	-	<b>S.06554</b>
30	-	8	-	<b>S.06555</b>
35	-	10	-	<b>S.06556</b>
-	1"	-	1/4"	<b>S.06201</b>
-	1 1/4"	-	1/4"	<b>S.06202</b>
-	1 3/8"	-	5/16"	<b>S.06203</b>

**Pinhole Yokes**

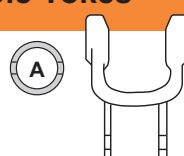

A		
mm	ins	
25	-	<b>S.06513</b>
30	-	<b>S.06514</b>
35	-	<b>S.06515</b>
-	1"	<b>S.06136</b>
-	1 1/4"	<b>S.06137</b>
-	1 3/8"	<b>S.06142</b>

**Clamp Yokes**

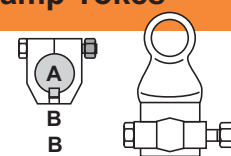

A		B		
mm	ins	mm	ins	
30	-	8	-	<b>S.06108</b>
35	-	10	-	<b>S.06109</b>
-	1 1"	-	1/4"	<b>S.06107</b>
-	1 1/4"	-	1/4"	<b>S.06135</b>

### Complete Shafts & Guards

#### Complete Shafts with 'Easy-Lock' Guards conforming to CEN 1152



Min		A		Max		Shafts
mm	ins	mm	ins	mm	ins	
500	20"	800	31"			S.06695
650	24"	1020	40"			S.61401*
750	29"	1300	51"			S.04637
1060	41.75"	1920	75.5"			S.13587*
1500	59"	2800	110"			S.06698

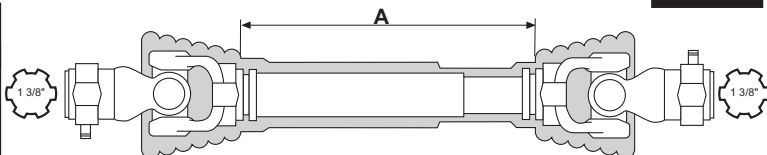

#### Shear Bolt Limiter

Min		A		Max		Shafts
mm	ins	mm	ins	mm	ins	
750	29.1"	1300	51"			S.61947*
880	34.7"	1730	68"			S.61454*

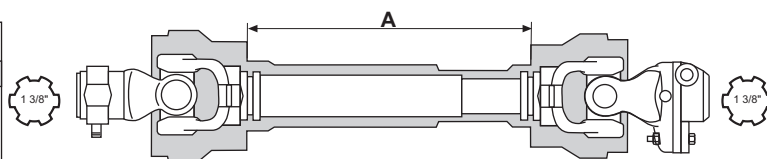

#### Round Bore

Min		A		Max		Shafts
mm	ins	mm	ins	mm	ins	
750	29.1"	1300	51"			S.61399*
880	34.7"	1730	68"			S.61400*

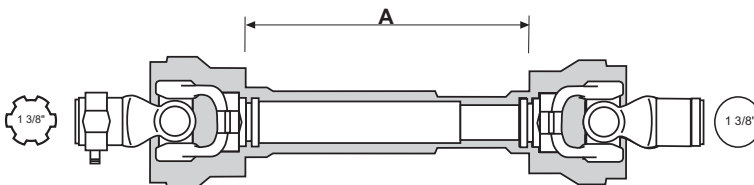

#### 'Easy-Lock' Guards - 250

Ring Kit* S.59636 47mm Ø x1 54mm Ø x1	A		Guard	Nipple Lock S.56509
	mm	ins		
	750	29.5"	S.59605	
	1000	39.5"	S.59606	
	1300	51.5"	S.59607	

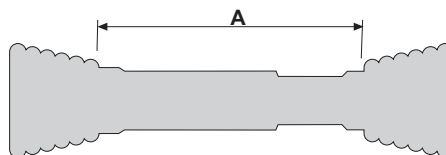

\*Kit Contains: 1x A=47mm Bearing, 1x A=54mm Bearing, 2 each S.56509 Nipple Locks

\*Featured Driveshaft have special pricing

### Assembled Couplings

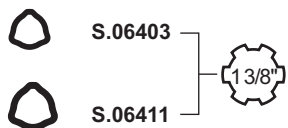
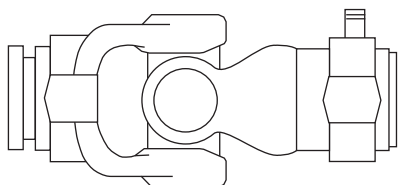

**Universal Joint**



**S.02497**

5.41  
41205

A = 30mm 1 3/16"  
B = 80mm 3 5/32"

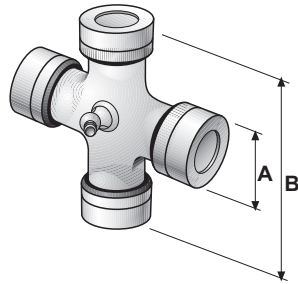

**Power-Torque Limit**

RPM	540 	1000 
h.p.	47	74

Values relate to continuous load,  
5° working angle, 1000 hrs life.

**NOTE:** P.T.O. tubing is sold in 5 foot lengths. If a longer length is required order the same number without the (.5) and a 10 ft length will be shipped. **NOTE:** Truck shipments only.

**Q. R. Yokes**

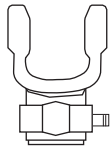

**S.06118**  
5.05.07  
507050351



**S.06119**  
5.05.08  
507053751



**S.06086**  
5.05.09  
507050451



**S.06112**  
5.05.10  
507053851



**Interfering Clamp Bolt Yokes**

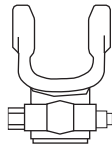

**S.07505**  
5.05.17  
509050352



**S.07515**  
5.05.18  
509053752



**Profile Tube Yokes**

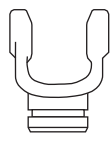

**S.06110**  
5.07  
204056852

**S.06111**  
5.06  
204056851

**Profile Tubes**  
(see note above)

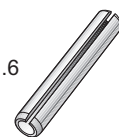
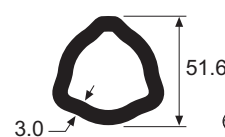
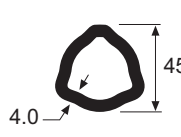

**S.04816.5**  
5.04  
12509

**S.04839.5**  
5.03  
12510

**S.01236**  
10 x 70mm

**Slip Clutches Torque Limiter**



**S.06025**  
K34  
1200Nm  
10600 ins lbs  
(4 row)



**Shear Bolt Limiter**

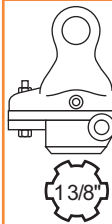

**S.06723**  
8 x 60mm

**S.06159**  
2100 Nm  
18500 ins lbs



**Free Wheel Overrunning Clutch**



**S.06054**  
RA1



**Friction Disc Clutch**

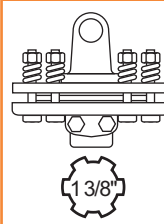

**S.06741**  
1200 Nm  
10620 ins lbs

**Keyway Yokes**

A		B		
mm	ins	mm	ins	
30	-	8	-	
35	-	10	-	
-	1 1/4"	-	1/4"	
-	1 1/4"	-	5/16"	<b>S.06562</b>
-	1 3/8"	-	5/16"	<b>S.06563</b>
<b>S.800-6510</b>				
<b>S.06564</b>				
<b>S.06565</b>				

**Pinhole Yokes**

A		
mm	ins	
30	-	
35	-	
-	1 1/4"	
-	1 3/8"	<b>S.06566</b>
		<b>S.06567</b>
		<b>S.06568</b>
		<b>S.06569</b>

### Complete Shafts & Guards

**Complete Shafts with 'Easy-Lock' Guards**  
conforming to CEN 1152



Min		A		Max		Shafts
mm	ins	mm	ins	mm	ins	
480	19"	760	30"			S.06434*
660	26"	1120	44.25"			S.13154*
1500	59"	2800	110"			S.06703*

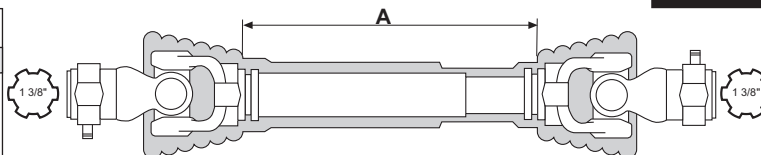

### 'Easy-Lock' Guards - 350

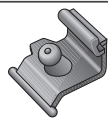
Ring Kit* S.59637 54mm Ø x1 62mm Ø x1 	A		Guard	Nipple Lock S.56509 
	mm	ins		
	750	29.5"	S.59613	
	1000	39.5"	S.59614	
	1300	51.5"	S.59615	

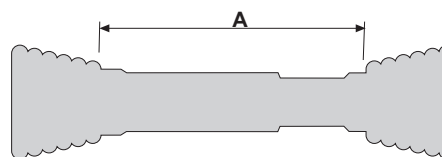

\*Kit Contains: 1x A=54mm Bearing,  
1x A=62mm Bearing,  
2 each S.56509 Nipple Locks

\*Featured Driveshafts have special pricing

### Special Shaft Record

### Assembled Couplings

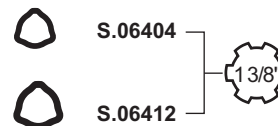
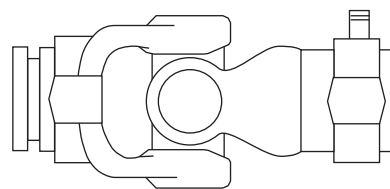

**Universal Joint**



**S.02449**  
6.41  
41206

A = 30mm 1 3/16"  
B = 92mm 3 5/8"

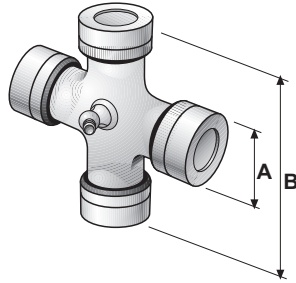

**Power-Torque Limit**

RPM	540 	1000 
h.p.	64	109

Values relate to continuous load, 5° working angle, 1000 hrs life.

**NOTE:** P.T.O. tubing is sold in 5 foot lengths. If a longer length is required order the same number without the (.5) and a 10 ft length will be shipped. **NOTE:** Truck shipments only.

**Q. R. Yokes**

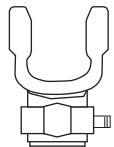

**S.06058**  
6.05.07  
507060351

**S.06059**  
6.05.08  
507063751

**S.06522**  
6.05.09  
507060451

**S.14430**  
6.05.10  
507063851

**Interfering Clamp Bolt Yokes**

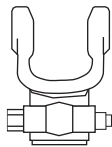

**S.07506**  
6.05.17

**S.07516**  
6.05.18

**S.07526**  
6.05.19

**Profile Tube Yokes**

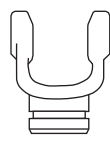

**S.06120**  
6.07  
204066852

**S.06121**  
6.06  
204066851

**Profile Tubes**  
(see note above)

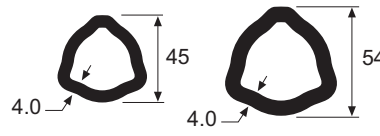

**S.04816.5**  
5.04  
12509

**S.04817.5**  
6.03  
12512

**Roll Pin**



**S.01237**  
10 x 80mm

**Slip Clutches Torque Limiter**



K33 900Nm **S.06057**  
7980 ins lbs (3 row)  
K343 1200Nm **S.06056**  
106400 ins lbs (4 row)



**Shear Bolt Limiter**

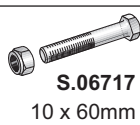
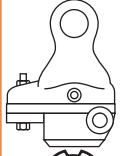

**S.06158**  
2400 Nm  
21240 ins lbs

**S.06298**

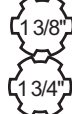

**Free Wheel Overrunning Clutch**

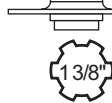
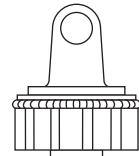

**S.06210**

**Friction Disc Clutch**

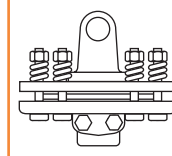

**S.06742**  
1200 Nm 10620 ins lbs

**S.06743**  
1800 Nm 15930 ins lbs

**Keyway Yokes**

A		B		
mm	ins	mm	ins	
30	-	8	-	<b>S.06558</b>
32	-	9	-	<b>S.06571</b>
35	-	10	-	<b>S.06559</b>
40	-	12	-	<b>S.06560</b>
-	1 1/4"	-	5/16"	<b>S.06204</b>
-	1 3/8"	-	5/16"	<b>S.06205</b>
-	1 1/2"	-	3/8"	<b>S.06206</b>

**Pinhole Yokes**

A		
mm	ins	
30	-	<b>S.06516</b>
35	-	<b>S.06517</b>
40	-	<b>S.06518</b>
-	1 1/4"	<b>S.06143</b>
-	1 3/8"	<b>S.06144</b>
-	1 1/2"	<b>S.06145</b>

**Clamp Yokes**

A		B		
mm	ins	mm	ins	
30	-	8	-	<b>S.06113</b>
35	-	10	-	<b>S.06114</b>
40	-	12	-	<b>S.06115</b>
-	1 1/4"	-	5/16"	<b>S.06282</b>
-	1 3/8"	-	5/16"	<b>S.06151</b>
-	1 1/2"	-	3/8"	<b>S.06152</b>

**Complete Shafts & Guards**

**Complete Shafts with 'Easy-Lock' Guards**  
conforming to CEN 1152



Min		A		Max		Shafts
mm	ins	mm	ins	mm	ins	
520	20.5"	840	33"			S.13588*
820	32.25"	1440	56.75"			S.04639*
1500	59"	2800	110"			S.06708

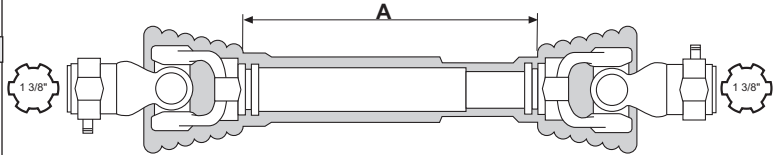

**Shear Bolt Limiter**

Min		A		Max		Shafts
mm	ins	mm	ins	mm	ins	
920	36.25"	1340	52.75"			S.13157*

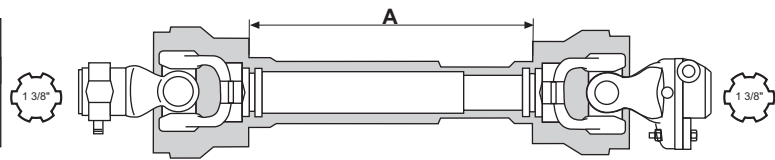

**'Easy-Lock' Guards - 350**

Ring Kit S.59638 60mm Ø x1 68mm Ø x1	A		Guard	Nipple Lock S.56509
	mm	ins		
	750	29.5"	S.59613	
	1000	39.5"	S.59614	
	1300	51.5"	S.59615	

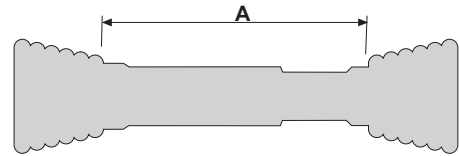

\*Contains: 1 x A=60mm Bearing,  
1 x A=68mm Bearing,  
2 each S.56509 Nipple Locks

\*Featured Driveshafts have special pricing

**Special Shaft Record**

**Assembled Couplings**

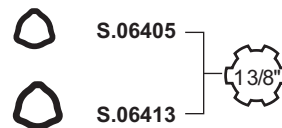
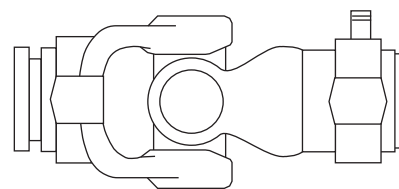



**Universal Joint**



**S.02458**

7.41

A = 30mm 1 3/16"  
B = 106.5mm 4 5/16"

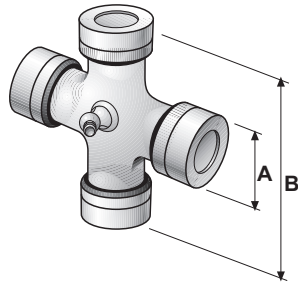

**Power-Torque Limit**

RPM	540 	1000 
h.p.	75	115

Values relate to continuous load, 5° working angle, 1000 hrs life.

**NOTE:** P.T.O. tubing is sold in 5 foot lengths. If a longer length is required order the same number without the (.5) and a 10 ft length will be shipped. **NOTE:** Truck shipments only.

**Q. R. Yokes**

**Interfering Clamp Bolt Yokes**

**Profile Tube Yokes**

**Profile Tubes**  
(see note above)

**Roll Pin**

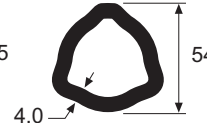
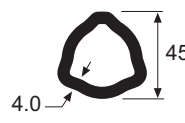
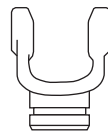
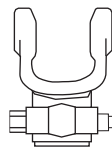
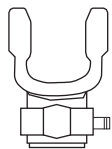

<b>S.06138</b> 7.05.07	
<b>S.06139</b> 7.05.08	
<b>S.06134</b> 7.05.09 507070451	
<b>S.06180</b> 7.05.10 507073851	

<b>S.07560</b> 7.05.17	
<b>S.07534</b> 7.05.18	
<b>S.07535</b> 7.05.19	

<b>S.06130</b> 7.07	
<b>S.06131</b> 7.06	

<b>S.04818.5</b> 75.04 12511	
<b>S.04817.5</b> 6.03 12512	

<b>S.01237</b> 10 x 80mm
-----------------------------

**Friction Disc Clutch**

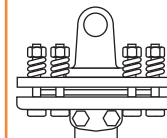

**S.06739**  
2000 Nm  
17700 ins lbs  
4 Disc

**Complete Shafts & Guards**

**Complete Shafts  
with 'Easy-Lock' Guards  
conforming to CEN 1152**



Min		A	Max		Shafts
mm	ins	mm	ins		
750	29"	1300	51"		S.06711

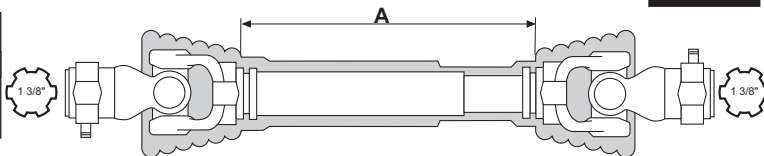

**'Easy-Lock' Guards - 350**

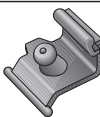
Ring Kit S.59638 60mm Ø x1 68mm Ø x1 	A		Guard	Nipple Lock S.56509 
	mm	ins		
	750	29.5"	S.59613	
	1000	39.5"	S.59614	
	1300	51.5"	S.59615	

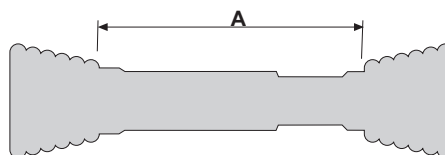

\*Contains: 1 x A=60mm Bearing,  
1 x A=68mm Bearing,  
2 each S.56509 Nipple Locks

**Special Shaft Record**

**Assembled Couplings**

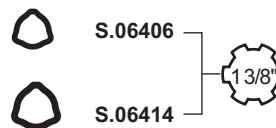
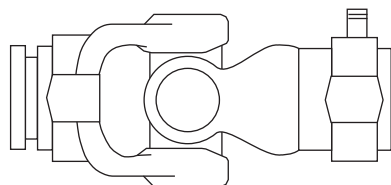

**Universal Joint**



**S.02499**  
41207

A = 35mm 1 3/8"  
B = 94mm 4 3/16"

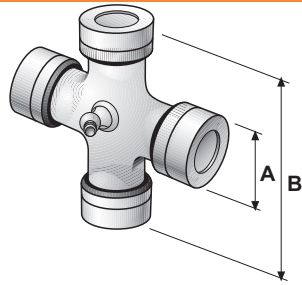

**Power-Torque Limit**

RPM	540 	1000 
h.p.	75	118

Values relate to continuous load, 5° working angle, 1000 hrs life.

**NOTE:** P.T.O. tubing is sold in 5 foot lengths. If a longer length is required order the same number without the (.5) and a 10 ft length will be shipped. **NOTE:** Truck shipments only.

**Q. R. Yokes**

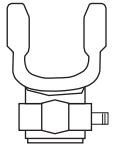

**S.06098**  
507170351



**S.06099**  
507173751



**S.07529**  
507170451



**S.07530**  
507173851



**Interfering Clamp Bolt Yokes**

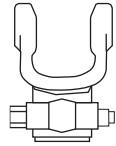

**S.07507**  
509170352



**S.07517**  
509173751



**S.07525**  
509170451



**Profile Tube Yokes**

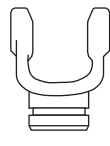

**S.06016**  
204176852



**S.06017**  
204176851

**Profile Tubes**  
(see note above)

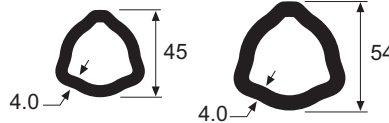

**S.04818.5**  
7.04  
12511

**S.04817.5**  
6.03  
12512

**Roll Pin**



**S.01237**  
10 x 80mm

**Keyway Yokes**

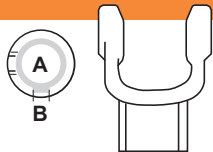

<b>A</b>		<b>B</b>		<b>S.07498</b>
mm	ins	mm	ins	
45	-	14	-	

**Shear Bolt Limiter**

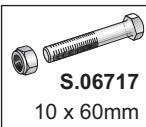
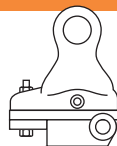

**S.06717**  
10 x 60mm



**S.06264**  
Bolt Type  
2920 Nm  
25840 ins lbs



**S.06265**

**Friction Disc Clutch**

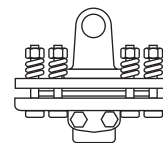

**S.06738**  
2000 Nm  
17700 ins lbs  
4 Disc

Complete Shafts & Guards

Complete Shafts  
with 'Easy-Lock' Guards  
conforming to CEN 1152



Min		A		Max		Shafts
mm	ins	mm	ins	mm	ins	
1000	39"	1800	71"			S.06418**

\*\*SPECIAL ORDER

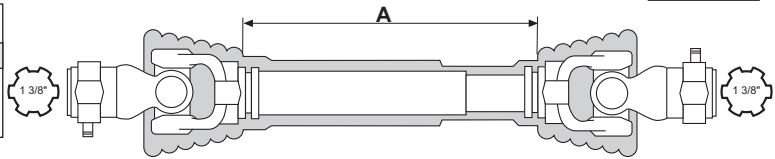

'Easy-Lock' Guards - 350

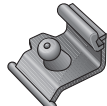
Ring Kit* S.59638 60mm Ø x1 68mm Ø x1	A		Guard	Nipple Lock S.56509
	mm	ins		
	750	29.5"	S.59613	
	1000	39.5"	S.59614	
	1300	51.5"	S.59615	

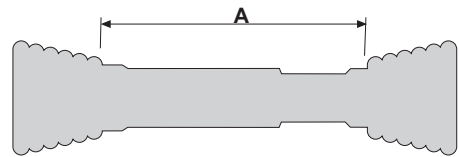

\*Kit Contains: 1 x A=60mm Bearing,  
1 x A=68mm Bearing,  
2 each S.56509 Nipple Locks

Special Shaft Record

Assembled Couplings

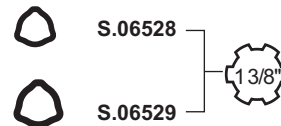
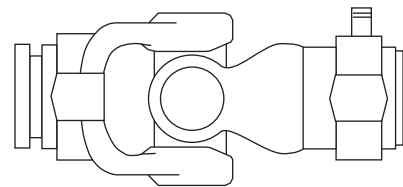

**Universal Joint**



**S.02496**  
8.41  
41208

A = 35mm 1 3/8"  
B = 106.5mm 4 3/16"

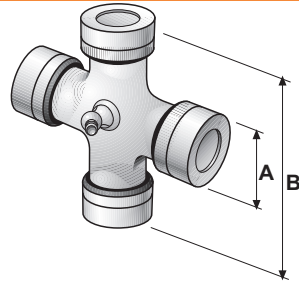

**Power-Torque Limit**

RPM	540 	1000 
h.p.	95	150

Values relate to continuous load, 5° working angle, 1000 hrs life.

**NOTE:** P.T.O. tubing is sold in 5 foot lengths. If a longer length is required order the same number without the (.5) and a 10 ft length will be shipped. **NOTE:** Truck shipments only.

**Q. R. Yokes**

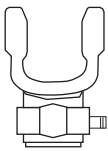

**S.06068**  
8.05.07  
507080351



**S.06069**  
8.05.08  
507083751



**S.06523**  
8.05.09  
507080451



**S.14431**  
8.05.10



**Interfering Clamp Bolt Yokes**

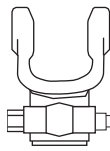

**S.07508**  
509080352



**S.07518**  
5090803751



**S.07528**  
509080452



**Profile Tube Yokes**

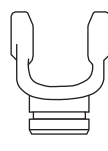

**S.06140**  
8.07



**S.06141**  
8.06

**Profile Tubes**  
(see note above)

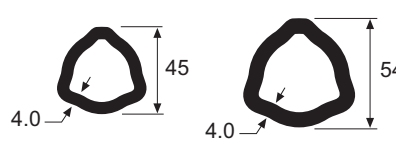

**S.04818.5**  
7.04  
12511

**S.04817.5**  
6.03  
12512



**S.01237**  
10 x 80mm

**Free Wheel Overrunning Clutch**

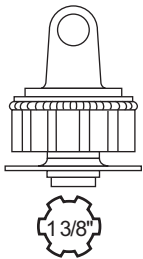

**S.06749**



**Shear Bolt Limiter**

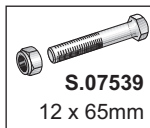
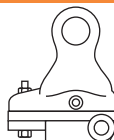

**S.07539**  
12 x 65mm



**S.07538**  
2400 Nm  
21240 ins lbs



**S.06266**  
2920 Nm  
25840 ins lbs

**Friction Disc Clutch**

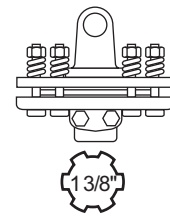

**S.06744**  
2000 Nm  
17700 ins lbs  
4 Disc



**S.06734**

**Keyway Yokes**

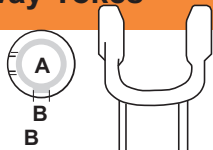

A		B		
mm	ins	mm	ins	
35	-	10	--	<b>S.06561</b>
40	-	12	-	<b>S.06722</b>
-	1 1/2"	-	3/8"	<b>S.06207</b>
-	1 5/8"	-	3/8"	<b>S.06208</b>

**Pinhole Yokes**

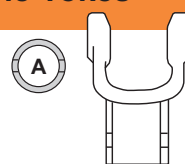

A		
mm	ins	
35	-	<b>S.06519</b>
40	-	<b>S.06521</b>
-	1 1/2"	<b>S.06146</b>
-	1 5/8"	<b>S.06147</b>

**Clamp Yokes**

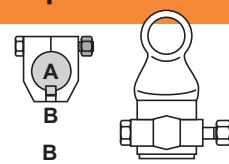

A		B		
mm	ins	mm	ins	
10	-	35	-	<b>S.06116</b>
12	-	40	-	<b>S.06117</b>
-	1 1/2"	-	3/8"	<b>S.06286</b>
-	1 5/8"	-	3/8"	<b>S.06287</b>

Complete Shafts & Guards

Complete Shafts with 'Easy-Lock' Guards conforming to CEN 1152



Min		A	Max		Shafts
mm	ins	mm	ins		
460	18"	720	28.25"	S.13332*	
750	29"	1300	51"	S.06751	
960	37.75"	1620	63.75"	S.13586**	
1500	59"	2800	110"	S.06753	

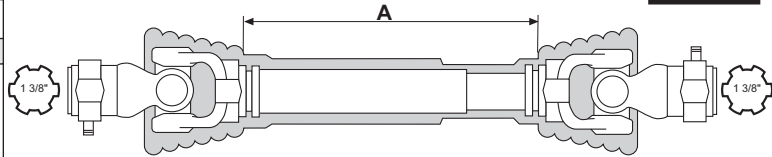

\*\*SPECIAL ORDER

'Easy-Lock' Guards - 350

Ring Kit S.59638 60mm Ø x1 68mm Ø x1	A		Guard	Nipple Lock S.56509
	mm	ins		
	750	29.5"	S.59613	
	1000	39.5"	S.59614	
	1300	51.5"	S.59615	

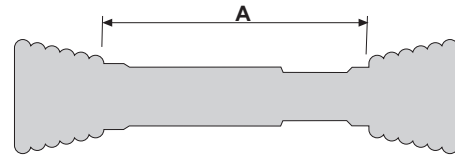

\*Contains: 1 x A=60mm Bearing,  
1 x A=68mm Bearing,  
2 each S.56509 Nipple Locks

\*Featured Driveshafts have special pricing

Special Shaft Record

Assembled Couplings

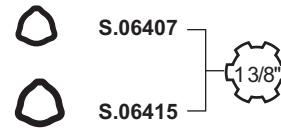
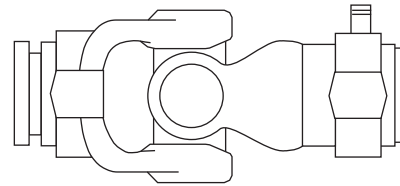

**Universal Joint**



**S.02496**  
8.41  
41208

A = 35mm 1 3/8"  
B = 106.5mm 4 3/16"

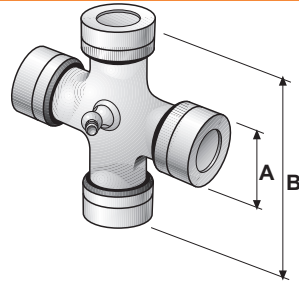

**Power-Torque Limit**

RPM	540 	1000 
h.p.	95	150

Values relate to continuous load, 5° working angle, 1000 hrs life.

**NOTE:** P.T.O. tubing is sold in 5 foot lengths. If a longer length is required order the same number without the (.5) and a 10 ft length will be shipped. **NOTE:** Truck shipments only.

**Q. R. Yokes**

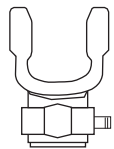

**S.06068**  
8.05.07  
507080351

**S.06069**  
8.05.08  
507083751

**S.06523**  
8.05.09  
507080451

**S.14431**  
8.05.10

**Interfering Clamp Bolt Yokes**

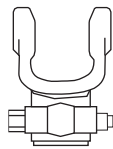

**S.07508**  
509080352

**S.07518**  
5090803751

**S.07528**  
509080452

**Profile Tube Yokes**

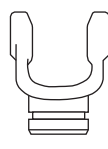

**S.07548**  
1204086861

**S.07549**  
204086860

**Profile Tubes**  
(see note above)

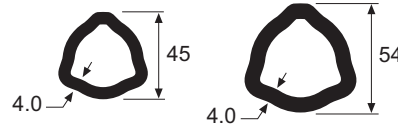

**S.04817.5**  
12512

**S.07547.5**  
12522

**Roll Pin**



**S.11482**  
12 x 90mm

**Free Wheel Overrunning Clutch**

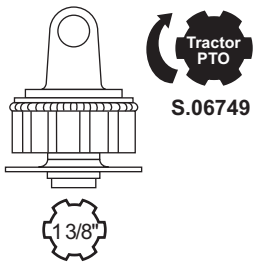

**S.06749**



**Shear Bolt Limiter**

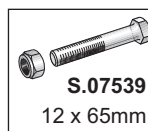
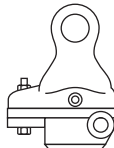

**S.07539**  
12 x 65mm

**S.07538**  
2400 Nm  
21240 ins lbs

**S.06266**  
2920 Nm  
25840 ins lbs



**Friction Disc Clutch**

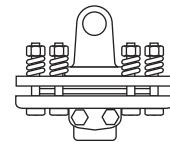

**S.06744**  
2000 Nm  
17700 ins lbs  
4 Disc

**S.06732**

**Keyway Yokes**

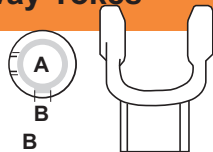

A		B		
mm	ins	mm	ins	
35	-	10	-	<b>S.06561</b>
40	-	12	-	<b>S.06722</b>
-	1 1/2"	-	3/8"	<b>S.06207</b>
-	1 5/8"	-	3/8"	<b>S.06208</b>

**Pinhole Yokes**

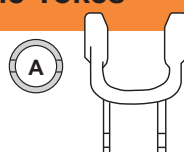

A		
mm	ins	
35	-	<b>S.06519</b>
40	-	<b>S.06521</b>
-	1 1/2"	<b>S.06146</b>
-	1 5/8"	<b>S.06147</b>

**Clamp Yokes**

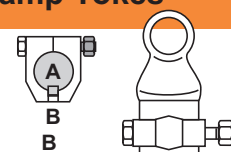

A		B		
mm	ins	mm	ins	
10	-	35	-	<b>S.06116</b>
12	-	40	-	<b>S.06117</b>
-	1 1/2"	-	3/8"	<b>S.06286</b>
-	1 5/8"	-	3/8"	<b>S.06287</b>

Complete Shafts & Guards

**Complete Shafts  
with 'Easy-Lock' Guards**  
conforming to CEN 1152



Min		A		Max		Shafts
mm	ins	mm	ins	mm	ins	
750	29"	1300	51"			S.06751

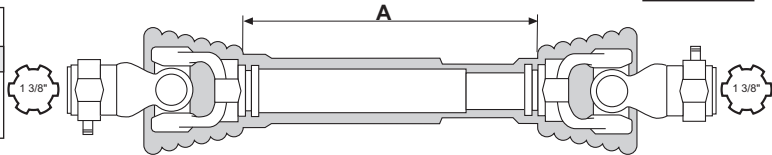

**'Easy-Lock' Guards - 350**

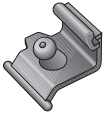
Ring Kit* S.59638 60mm Ø x1 68mm Ø x1 	A		Guard	Nipple Lock S.56509 
	mm	ins		
	750	29.5"	S.59613	
	1000	39.5"	S.59614	
	1300	51.5"	S.59615	

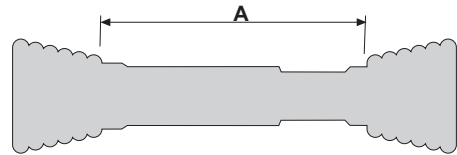

\*Kit Contains: 1 x A=60mm Bearing,  
1 x A=68mm Bearing,  
2 each S.56509 Nipple Locks

**Special Shaft Record**

**Assembled Couplings**

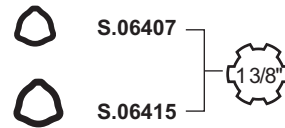
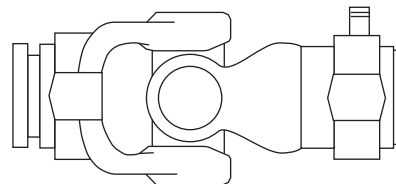



Universal Joint



S.51983  
9.81  
41209

A = 415mm 1 39/64"  
B = 108mm 4 1/4"

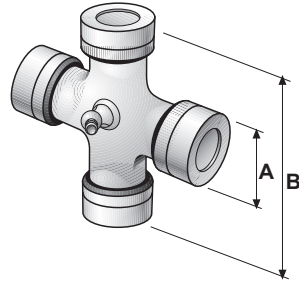

Power-Torque Limit

RPM	540 	1000 
h.p.	120	190

Values relate to continuous load, 5° working angle, 1000 hrs life.

**NOTE:** P.T.O. tubing is sold in 5 foot lengths. If a longer length is required order the same number without the (.5) and a 10 ft length will be shipped. **NOTE:** Truck shipments only.

Q. R. Yokes

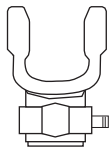

- S.07540  
507190351
- S.07541  
507193751
- S.07542  
507190451
- S.07543  
507193851

Interfering Clamp Bolt Yokes

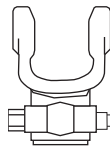

- S.07509  
9.05.17
- S.07519  
9.05.18

Profile Tube Yokes

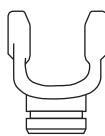

- S.07544  
204196852
- S.07545  
204196851

Profile Tubes  
(see note above)

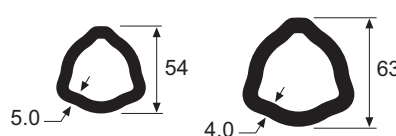

- S.07546.5  
12513

- S.07547.5  
12522

Roll Pin



- S.11482  
12 x 90mm

Complete Shafts & Guards

Complete Shafts with 'Easy-Lock' Guards conforming to CEN 1152

Min		A		Max		Shafts
mm	ins	mm	ins	mm	ins	
1000	39"	1800	71"			S.13740**

\*\*SPECIAL ORDER

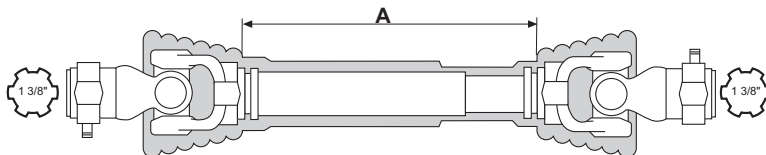

'Easy-Lock' Guards - 450

Ring Kit* S.59639 68mm Ø x1 80mm Ø x1 	A		Guard	Nipple Lock S.56509 
	mm	ins		
	750	29.5"	S.59621	
	1000	39.5"	S.59622	
	1300	51.5"	S.59623	

\*Kit Contains: 1x A=68mm Bearing, 1x A=80mm Bearing, 2 each S.56509 Nipple Locks

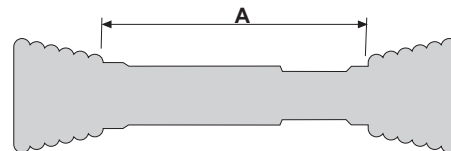

**Universal Joint**

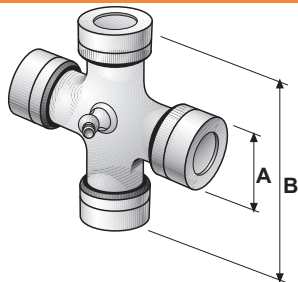

**S.07500**  
10.41  
41210  
A = 41mm      1 39/64"  
B = 118mm     4 41/64"

**Power-Torque Limit**

RPM	540 	1000 
h.p.	145	230

Values relate to continuous load, 5° working angle, 1000 hrs life.

**NOTE:** P.T.O. tubing is sold in 5 foot lengths. If a longer length is required order the same number without the (.5) and a 10 ft length will be shipped. **NOTE:** Truck shipments only..

**Q. R. Yokes**

**Interfering Clamp Bolt Yokes**

**Profile Tube Yokes**

**Profile Tubes**  
(see note above)

**Roll Pin**

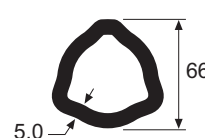
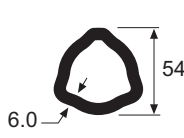
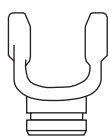
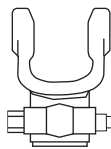
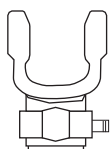

<b>S.07550</b> 507100351	
<b>S.07551</b> 507103751	
<b>S.07552</b> 507100451	
<b>S.07553</b> 507103851	

<b>S.07510</b> 10.05.17	
<b>S.07520</b> 10.05.18	

<b>S.07554</b> 204106852	
<b>S.07555</b> 204106851	

<b>S.07556.5</b> 12514
---------------------------

<b>S.07557.5</b> 12515
---------------------------

<b>S.11482</b> 12 x 90mm
<b>S.01243</b> 12 x 100mm

**Complete Shafts & Guards**

**Complete Shafts with 'Easy-Lock' Guards conforming to CEN 1152**

Min		A		Max			Shafts
mm	ins	mm	ins	mm	ins		
1000	39"	1800	71"				<b>S.13832**</b>

\*\*SPECIAL ORDER

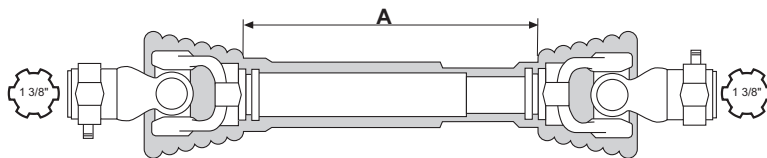

**'Easy-Lock' Guards - 450**

Ring Kit* S.59639 68mm Ø x1 80mm Ø x1 	A		Guard	Nipple Lock S.56509 
	mm	ins		
	750	29.5"	<b>S.59621</b>	
	1000	39.5"	<b>S.59622</b>	
	1300	51.5"	<b>S.59623</b>	

\*Kit Contains: 1x A=68mm Bearing, 1x A=80mm Bearing, 2 each S.56509 Nipple Locks

Complete 70° Wide Angle Joints

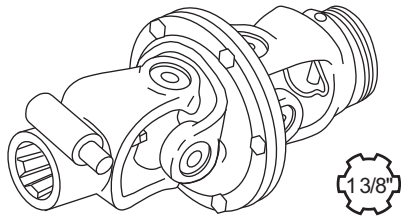

Operation: Max 70° Short Duration  
Max 35° In Continuous Operation.

Allows P.T.O shaft to operate up to an angle of 70°  
Designed to fit 21 Series (2300 Type)

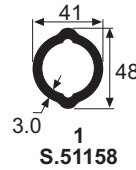
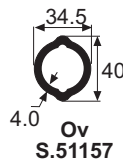

Wide Angle Guards

'Easy-Lock' Guards - 2380 Series

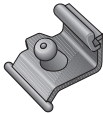
Ring Kit* S.59644 50mm Ø x2	A		Guard	Nipple Lock S.56509
	mm	ins		
	750	29.5"	S.59624	
	1000	39.5"	S.59625	

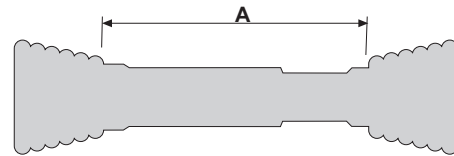

\*Kit Contains: 1x A=50mm Bearing, 1x A=50mm Bearing, 2 each S.56509 Nipple Locks  
**NOTE:** One end bell may need to be removed to fit CV Assembly

Wide Angle Guards

'Easy-Lock' Guards - 2480 Series

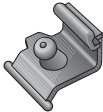
Ring Kit* S.59632 63mm Ø x2	A		Guard	Nipple Lock S.56509
	mm	ins		
	750	29.5"	S.59628	
	1000	39.5"	S.59629	

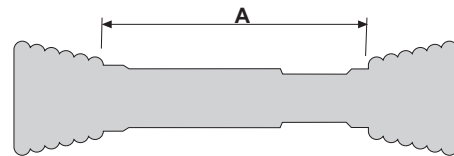

\*Kit Contains: 1x A=63mm Bearing, 1x A=63mm Bearing, 2 each S.56509 Nipple Locks

Complete 80° Wide Angle Joints and Components - Welded Assembly

2380 Series

Operation:  
Max 80° Short Duration  
Max 35° In Continuous Operation

RPM	540	1000	RPM	540	1000
10°	6	2	20°	6	2
1000 hrs			100 hrs		
h.p.	29	45		46	71

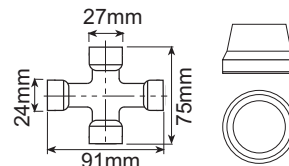
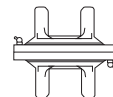
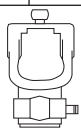
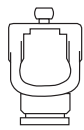
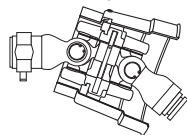

To Suit Tube	Tube Dim	Complete Joint c/w Shield	Profile Tube Yoke	Q.R. Yoke 6 Spline 1.3/8"	Q.R. Yoke 21 Spline 1.3/8"	Center Assembly	Universal Joint	Yoke Shield
A4 Inner Tube	36mm	S.06645	S.71524	S.71520	S.06678	S.71521	S.51152	S.06638
A3/A4 Outer Tube	43.5 mm	S.06646	S.71523	S.71520	S.06678	S.71521	S.51152	S.06638
1	41mm	S.06650	S.06661 21.12.810	S.71520	S.06678	S.71521	S.51152	S.06638
Ov	34.5 mm	S.06651	S.06660 21.11.810	S.71520	S.06678	S.71521	S.51152	S.06638
1b	39.5 mm	S.06652	S.06662 21.42.810	S.71520	S.06678	S.71521	S.51152	S.06638
2a	48 mm	S.06653	S.06663 21.43.810	S.71520 21.10.810	S.06678	S.71521 21.91.05	S.51152 21.06.00	S.06638

2480 Series

Operation:  
Max 80° Short Duration  
Max 35° In Continuous Operation

RPM	540	1000	RPM	540	1000
10°	6	21	20°	6	21
1000 hrs			100 hrs		
h.p.	41	63		64	98

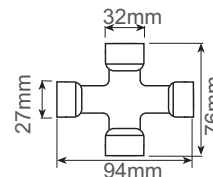

To Suit Tube	Tube Dim	Complete Joint c/w Shield	Profile Tube Yoke	Q.R. Yoke 6 Spline 1.3/8"	Q.R. Yoke 21 Spline 1.3/8"	Center Assembly	Universal Joint	Yoke Shield
A5/A6 Inner Tube	45mm	S.06647	S.71526	S.71522	S.06679	S.06665	S.51153	S.06669
A6 Outer Tube	54mm	S.06648	S.71525	S.71522	S.06679	S.06665	S.51153	S.06669
S4	51mm	S.06655	S.06668	S.71522	S.06679	S.06665	S.51153	S.06669
1b	39.5 mm	S.06657	S.06666 35.13.10	S.71522	S.06679	S.06665	S.51153	S.06669
2a	48mm	S.06658	S.06667 35.14.10	S.71522 35.10.10	S.06679	S.06665 35.41.05	S.51153 35.06.00	S.06669

2580 Series

Operation:  
Max 80° Short Duration  
Max 35° In Continuous Operation

RPM	540	1000	RPM	540	1000
10°	6	21	20°	6	21
1000 hrs			100 hrs		
h.p.	68	105		107	163

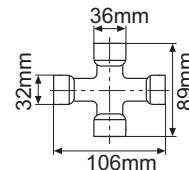

To Suit Tube	Tube Dim	Complete Joint c/w Shield	Profile Tube Yoke	Q.R. Yoke 6 Spline 1.3/8"	Q.R. Yoke 21 Spline 1.3/8"	Center Assembly	Universal Joint	Yoke Shield
1b	39.5mm	S.10589	S.10593	S.10597	S.10598	S.10599	S.50908	S.10670
2a	48mm	S.10590	S.10594	S.10597	S.10598	S.10599	S.50908	S.10670
S4	51mm	S.10591	S.10595	S.10597	S.10598	S.10599	S.50908	S.10670
S5	61mm	S.10592	S.10596	S.10597	S.10598	S.10599	S.50908	S.10670

Yoke Pins



	Replaces/For	mm	ins	Loose Part	S.03217	S.03218	S.05786	S.06588	S.11158	S.06530
	SK 32 81/E 1810351 M91 British & American Yokes	A 14 B 25.4 C 12.7 D 17	9/16" 1" 1/2" 21/32"	S.01090	2	-	-	-	-	10
	00.08.00 Various German Type Yokes	A 12.7 B 19 C 14 D 19	1/2" 3/4" 9/16" 3/4"	S.01099	-	2	-	-	-	10
	339 107 2000 Series German Type Yokes	A 7.5 B 33.5 C 10.5 D 13	9/32" 15/16" 13/32" 1/2"	S.05735	-	-	2	-	-	4
	1.08.25 401000001 Various Italian Type Yokes	A 13.9 B 22 C 12 D 11	17/32" 7/8" 15/32" 7/16"	S.06587	-	-	-	2	-	5
	1.08.25.01 403000001 Various Italian Type Yokes	A 13.9 B 8 C 47 D 20	35/64" 5/16" 1 13/16" 25/32"	S.11122	-	-	-	-	2	5
	Sparex P.T.O. Adaptors	A 13 B 18 C 17 D 12	1/2" 23/32" 11/16" -	S.04176	-	-	-	-	-	4
	1.3/4" x 6 Splined Adaptors	A 12.7 B 23.5 C 15.5 D 18	1/2" 15/16" 5/8" 23/32"	S.14105	-	-	-	-	-	-
	403000011 Various Italian Type Yokes	A 15.9 B 8 C 65.5 D 30.5	5/8" 5/16" 2 1/2" 1 3/16"	S.14106	-	-	-	-	-	-
	Sparex Shear Bolt Limiters	A 13 B 23 C 14 D		S.14107	-	-	-	-	-	-

Replacement Friction Clutch Discs

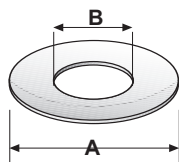

Part Number	A OD	B ID	Thick
S.06677	5 1/2"	3 3/8"	-
S.06684	6 5/16"	3 3/4"	3/16"
S.06689	6"	3 9/16"	1/8"

Roll Pins - PTO Equipment

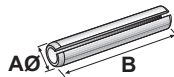

Part Number	AØ mm	B
S.01207	8 x	50
S.01228	8 x	55
S.01230	8 x	70
S.01235	10 x	65
S.01236	10 x	70
S.01237	10 x	80
S.01238	1 x	90
S.01172	1/2" x	4



S.06574  
22 pcs

S.06531  
90 pcs

PTO Tube Tool

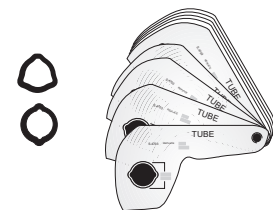

S.03844

An invaluable PTO Tool with cutout to identify tube profiles. Fully dimensioned with German/Italian cross references.

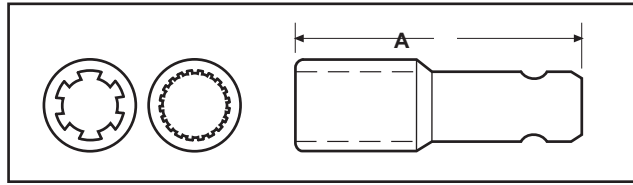

PTO Adaptors



Adaptor Type	Female Spline		Male Spline		Increases PTO Shaft Length by	Overall Length	Part Number
	∅ F		∅ M				
Extension Adaptors	1 3/8"	x 6	1 3/8"	x 6	4"	5 3/4"	S.00255 S.00254
					7"	9 7/16"	
Universal Reducer	1 3/8"	x 6	1 1/8"	x 6	2 7/8"	5 3/8"	S.00251
Converters	1 3/4"	x 20	1 3/8"	x 6 x 21	5"	7 3/8"	S.08443 S.08441
Heavy Duty Increases	1 1/8"	x 6	1 3/8"	x 6 x 21	2 3/4" 3"	4 3/4"	S.00252
Adaptor Assembly Fits Compact Tractors	1"	x 18	1 3/8"	x 6	3"	5"	S.15073

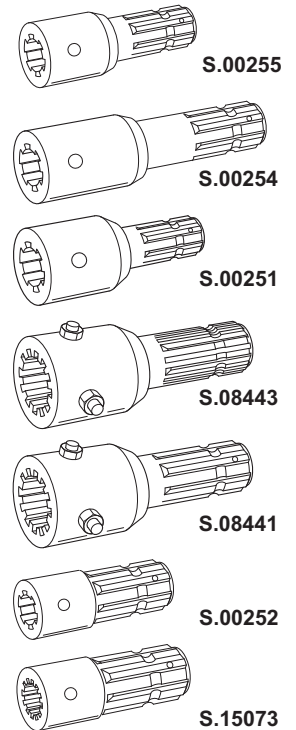

Sleeve Increases

Female Spline		Male Spline		Overall Length A	Part Number
∅ F		∅ M			
1 1/8"	x 6	1 3/8"	x 6	2 3/16" 3 3/16"	S.00249 S.00253*

\*Less S.00248 Roll Pin

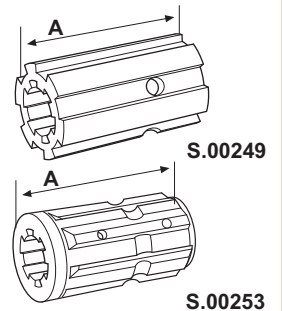

Quick Disconnect Push Pin Adaptors

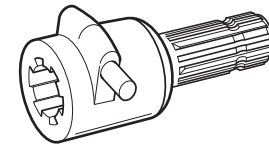
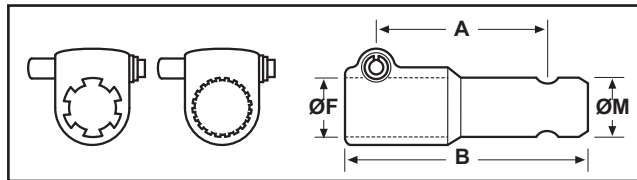

Quick Release Type

Female Spline Ø F	Male Spline Ø M	Increases P.T.O. Shaft Length by	Overall Length	Quick Release Type Part Number	
				A ins	B ins
1 1/8" x 6	1 3/8" x 6	4 5/16"	6 1/2"	S.15720	-
1 3/8" x 6	1 3/8" x 6	4 5/16"	6 1/2"	S.03737	S.15901
	1 3/8" x 21	4 3/4"		S.13393	S.15903
	1 1/8" x 6	5 1/8"		S.15678	-
1 3/8" x 21	1 3/8" x 6	4 5/16"	6 1/2"	S.13380	S.15865
	1 3/8" x 21	4 3/4"		S.03740	S.15907
	1 1/8" x 6	5 1/8"		S.15727	-
1 3/4" x 6	1 3/8" x 6	5"	7 7/8"	-	S.16245
	1 3/8" x 21	5 1/2"		-	-
1 3/4" x 20	1 3/8" x 6	5 1/2"	7 7/8"	-	S.16247
	1 3/8" x 21	5 1/2"		-	-

Quick Disconnect Adaptor

Rotating Lock Collar Type -  
Up to 75hp  
Black

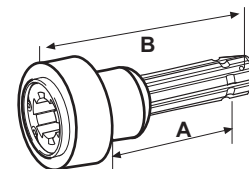

Female Spline Ø F	Male Spline Ø M	Increases P.T.O. Shaft Length by	Overall Length	Quick Release Type Part Number	
				A ins	B ins
1 3/8" x 6	1 3/8" x 21	3 1/2"	6 1/2"	S.13377	-
1 3/8" x 21	1 3/8" x 21	3 1/2"	6 1/2"	S.13379	-

Bolt Adaptors

**Bolt Type**

- + 1 Bolt
- \* 1 Allen Head Bolt
- \*\* 2 Allen Head Bolts

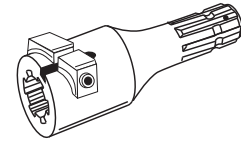
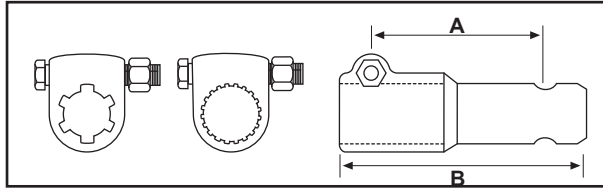



Female Spline Ø F	Male Spline Ø M	Increases P.T.O. Shaft Length by	Overall Length	Bolt Type Part Number		
				Standard Up to 70 h.p	Heavy Duty Over 70 h.p	
1 3/8" x 6	1 3/8" x 6	4 5/16"	6 1/2"	S.03741	S.15902	
	1 3/8" x 21	4 3/4"		S.03742	S.15904	
	1 1/8" x 6	5 1/8"		-	-	
1 3/8" x 21	1 3/8" x 6	4 5/16"		S.03743+ S.13381*	S.15866	
	1 3/8" x 21	4 3/4"		S.03744	-	
	1 1/8" x 6	5 1/8"		-	-	
1 1/8" x 6	1 3/8" x 6	4 5/16"	6 1/2"	-	-	
	1 3/8" x 21	4 3/4"		-	-	
	1 1/8" x 6	5 1/8"		S.15723	-	
1 3/4" x 6	1 3/8" x 21	5 1/2"		7 7/8"	-	-
	1 3/8" x 6	5"			-	S.16249
1 3/4" x 20	1 3/8" x 21	5 1/2"			S.13372*	S.13371**
	1 3/8" x 6	5"	S.13374*		S.16251+ S.13373**	



Special Adaptors

PTO Overrunning Coupler - Black

Female Spline ins		Male Spline ins		Increases P.T.O Shaft Length by ins	Part Number
1 1/8"	x 6	1 1/8"	x 6	4 3/8"	S.13376
1 1/8"		1 3/8"			S.15451
1 3/8"		1 1/8"			S.13375
1 3/8"		1 3/8"			S.15514

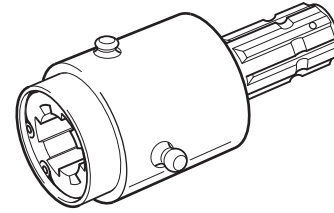

General Purpose and Pump Adaptors

Female Spline Ø F ins		Ø A ins	Ø B ins	Overall Length L ins	Part Number
1 3/8"	x 6	5/8"	1 3/8"	4 5/8"	S.04981
		3/4"			S.04982
		1"			S.04984

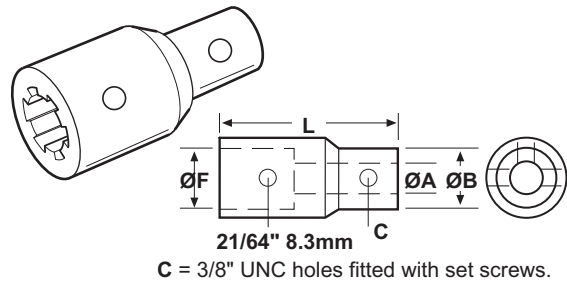

Push Button Sleeve

S.04467

Ø F = 1 3/8" x 6 Splines

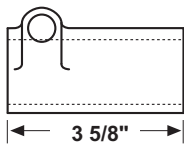
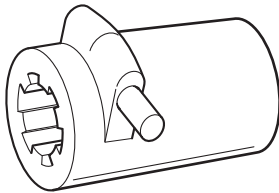

Quick Release Adaptor

S.15229

Ø F = 1 3/8" x 6 Splines

Ø A = .944"/.946"

Ø B = Fitted with set screws

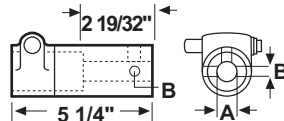
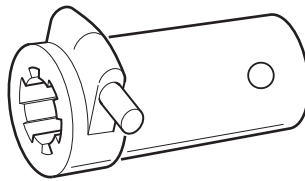

Splined Couplings

Female Spline ins		Overall Length L ins	Part Number
1 1/8"	x 6	2 3/4"	S.00286
1 3/8"		3 3/4"	S.00287
1 3/4"	x 20		S.15731
			S.15733

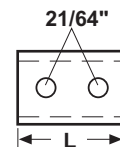
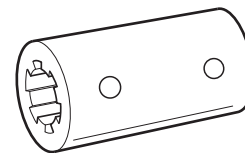

Splined Shafts

Splined Shafts - 6 Spline

Spline Ø	No. of Splines	B	C	D	E	Part Number
1 3/8"	6	5 7/8"	2 61/64"	1 1/2"	1 3/8"	S.16426
		13 3/4"				S.16427

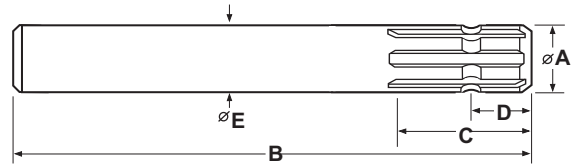

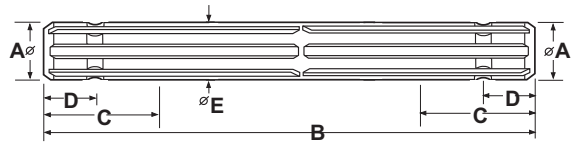

Splined Shafts - 6 Spline

Spline Ø	No. of Splines	B	C	D	E	Part Number
1 3/8"	6	11 13/16"	3"	1 1/2"	1 3/8"	S.16428
		5 7/8"				S.16615



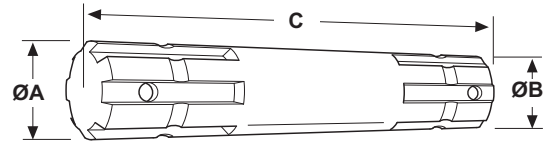

Extension Shafting - 6 Spline

Ø A		Ø B		Length C	Part Number
ins		ins		ins	
1 3/8"	x 6	1 1/8"	x 6	9"	S.00278
		1 3/8"			S.00279



Repair Shafting - 6 Spline

Ø A		Length B	Part Number
ins		ins	
1 3/8"	x 6	10"	S.00283

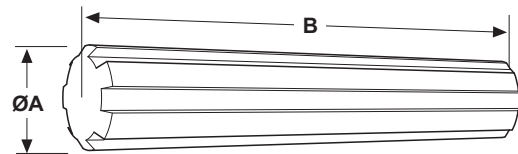

Easy Lock Safety Guards



- New Series of High Specification Safety Guards
- Approved to CEN 1152
- Fits North American and Metric Drive Shafts

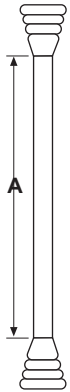

North American (NA)



Walterscheid (W)



Bondioli/Pavesi (BP)

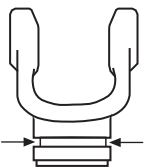

A-ID

A	250	350	450		
29.50" 750mm	S.59605	S.59613	S.59621		
39.25" 1000mm	S.59606	S.59614	S.59622		
51.125" 1300mm	S.59607	S.59615	S.59623		
<b>BEARING KITS</b> (w/ Nipple Locks S.56509 x 2, Bearing Rings x 2)					
<b>TYPE A - 250 - NORTH AMERICAN</b>					
<b>STOCK NO</b>	<b>SERIES</b>	<b>GUARD</b>	<b>A - ID</b>	<b>A - ID</b>	<b>B - OD</b>
S.22566	6	250	46.4mm/1.83"	46.4mm/1.83"	71.4mm/2.81"
S.22567	12, 14, 35	250	52.8mm/2.08"	52.8mm/2.08"	71.4mm/2.81"
S.22568	W	250	41.8mm/1.65"	41.8mm/1.65"	71.4mm/2.81"
<b>TYPE A - 250 - METRIC</b>					
<b>STOCK NO</b>	<b>SERIES</b>	<b>GUARD</b>	<b>A - ID</b>	<b>A - ID</b>	<b>B - OD</b>
S.56550	BP A1	250	34mm/1.36"	40mm/1.59"	71.4mm/2.81"
S.59635	BP A2	250	40mm/1.59"	47mm/1.87"	71.4mm/2.81"
S.59636	BP A3, A4	250	47mm/1.87"	54mm/2.10"	71.4mm/2.81"
S.56500	W 2100, 2200	250	41mm/1.63"	41mm/1.63"	71.4mm/2.81"
S.59631	W 1, 2200, 2300	250	50mm/2.00"	50mm/2.00"	71.4mm/2.81"
<b>TYPE B - 350 - NORTH AMERICAN</b>					
<b>STOCK NO</b>	<b>SERIES</b>	<b>GUARD</b>	<b>A - ID</b>	<b>A - ID</b>	<b>B - OD</b>
S.22569	44, 55	350	67.2mm/2.65"	67.2mm/2.65"	83.6mm/3.29"
<b>TYPE B - 350/450 - METRIC</b>					
<b>STOCK NO</b>	<b>SERIES</b>	<b>GUARD</b>	<b>A - ID</b>	<b>A - ID</b>	<b>B - OD</b>
S.59637	BP A5	350	54mm/2.11"	62mm/2.47"	83.6mm/3.29"
S.59638	BP A6, A7, A8	350	60mm/2.34"	68mm/2.69"	83.6mm/3.29"
S.59639	BP A9, A10	450	68mm/2.69"	80mm/3.17"	103mm/4.05"
S.59632	W 11, 220, 240, 2300, 2400, 2500	350	63mm/2.46"	63mm/2.46"	83mm/3.27"
S.59633	W 2600	450	82mm/3.26"	82mm/3.26"	103mm/4.05"
<b>WIDE ANGLE GUARDS</b>					
<b>A</b>	<b>2380 SERIES</b>	<b>2480 SERIES</b>	<b>S.56509</b> (Use 2 per Guard)		
29.50" 750mm	S.59624	S.59628			
39.25" 1000mm	S.59625	S.59629			
<b>BEARING KITS</b> (w/ Nipple Locks S.56509 x 2)					
	<b>STOCK NO</b>	<b>SERIES</b>	<b>A - ID</b>	<b>A - ID</b>	<b>B - OD</b>
	S.59632	W 2480	63mm/2.5"	63mm/2.5"	
	S.59644	W 2380	50mm/1.97"	50mm/1.97"	